

ProntoPorta
AUDASSO[®]

EDIZIONE 5



EDIZIONE N° 5 - AGOSTO 2022



BIENNE S.r.l.
Via Santa Sofia, 21 - 20122 Milano
www.prontoportaaudasso.it

CATALOGO RISERVATO
AL RETAIL ITALIA
EDIZIONE 5
AGOSTO 2022

PORTE IN PRONTA CONSEGNA	2
FINITURE	4
CIECA LISCIA	6
DYNAMIC	10
CROSS	14
CLASSIC	18
STYLE	22
TRENDY	26
BIANCO MATRIX	30
BIANCO MATRIX VETRO	34
AVENA MATRIX - AVENA MATRIX VETRO	38
CALCE	42
BIANCO STRUTTURA	46
RISO	50
ORZO	54
FARRO	58
BIANCO HD - BIANCO HD VETRO	62
NOCE NAZIONALE - NOCE NAZIONALE VETRO	66
LATTE	70
CORDA	74
QUADRA BIANCO	78
BAND	82
TONDA NOCE	86
TONDA ECRÙ	90
TONDA BIANCO	94
FILOMURO PRIMER	98
BLINDATI	100
SISTEMA SCORREVOLE ESTERNO MURO - ACCESSORI	112
MANIGLIE	114
ALLARGAMENTI - BATTISCOPI	116
SEZIONI TELAI	118
SCHEDE TECNICHE	120
PRODOTTI PER L'INSTALLATORE E IMBALLI	128
TRASPORTO	130
SISTEMI ORDINABILI	132

Scegli, Clicca, La Tua Porta è Pronta

La gamma di porte composta da una selezione di colori, disegni, finiture e soluzioni tecniche creata grazie alla nostra esperienza per proporre ai nostri partner qualificati una nuova opportunità di business: porte di alta qualità dal prezzo accessibile a tutti, disponibili per il libero mercato “no name”, retail o online stores e in pronta consegna Franco Fabbrica in 48 ore.

Servizio garantito
soddisfatti o rimborsati.

*538 articoli, porte e accessori in pronta consegna
presso la nostra sede. Scegli come riceverle.*

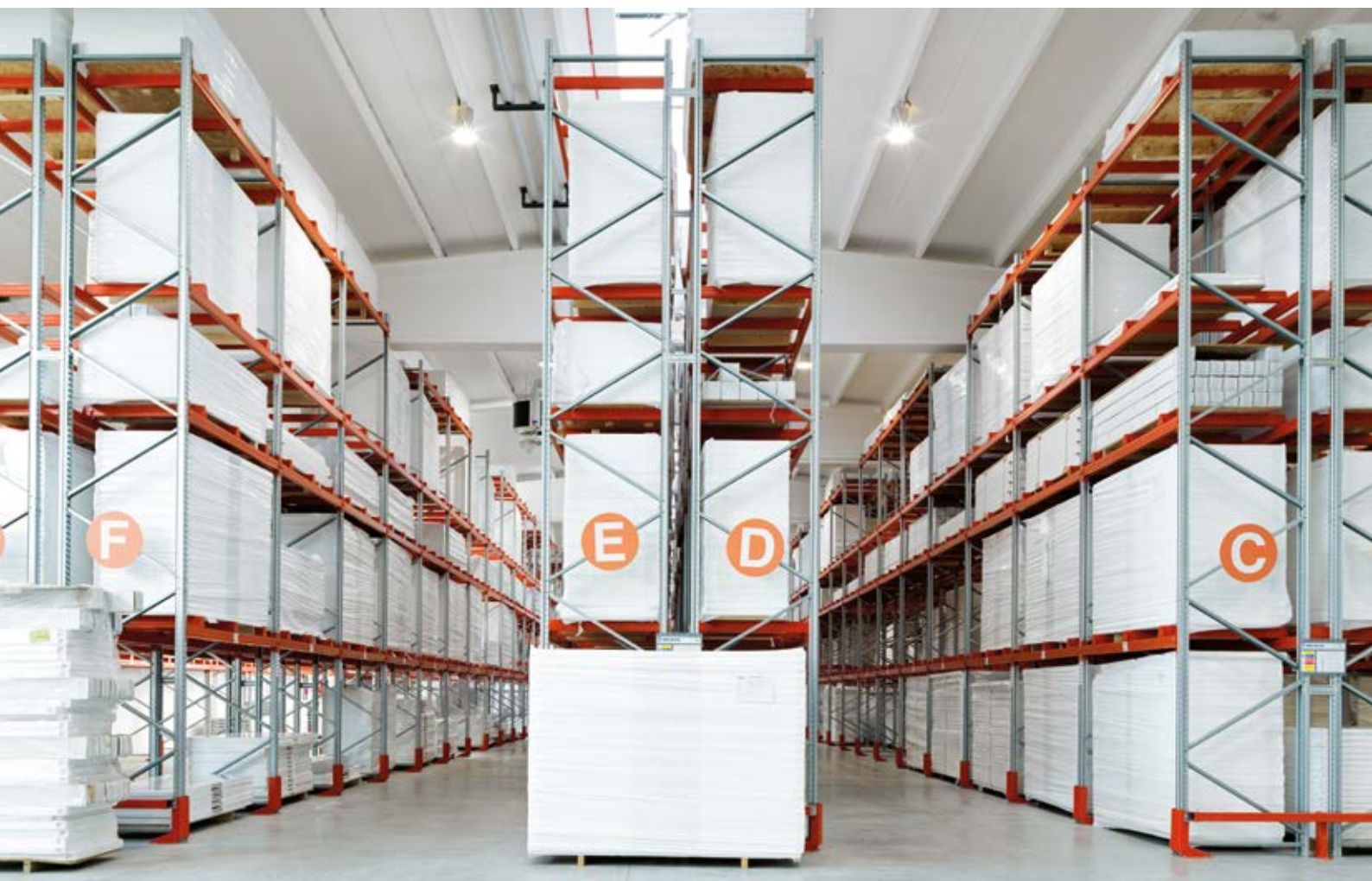

Gamma finiture porte e rivestimenti per ambienti interni



CALCE



RISO



BIANCO STRUTTURA



ORZO

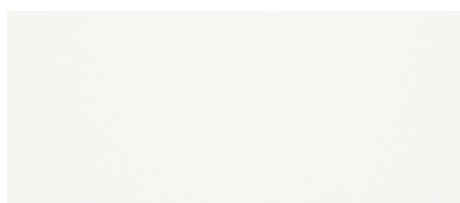

BIANCO HD*



FARRO



NOCE NAZIONALE
TONDA NOCE

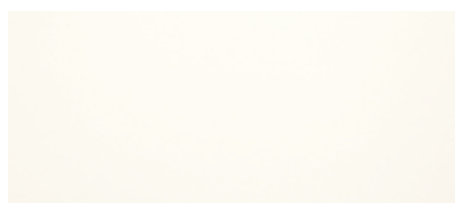

BIANCO LACCATO

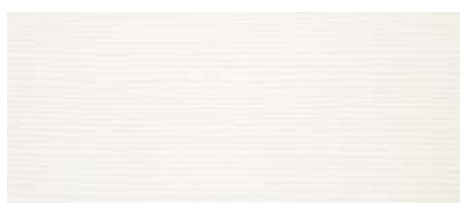

BIANCO MATRIX



MOGANO**



AVENA MATRIX



LATTE

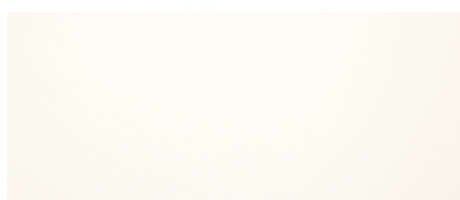

BIANCO MICRO**



CORDA



TONDA ECRÙ



TANGANICA

* BIANCO HD

= LAMINATO CPL

** BIANCO MICRO, MOGANO E TANGANICA = MICRO LAMINATO

Gamma finiture rivestimenti per ambienti esterni

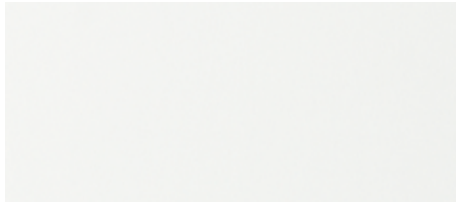

TORINESE
BIANCO PVC



MILANESE
NOCE PVC



MILANESE
CIOCCOLATO PVC



CREMONESE
TORTORA PVC



PAVESE
GRIGIO PVC



GENOVESE
ROVERE PVC



CREMONESE
OKOUMÈ NOCE
COMPENSATO
MARINO

CIECA LISCIA
BIANCO LACCATO
BATTENTE



CIECA LISCIA
BIANCO LACCATO
DOUBLÉ



CIECA LISCIA



CIECA LISCIA

- A** Battente reversibile
- C** BIANCO LACCATO
- T** TLS/L8
- M** Linea cromo sat.
- P** Liscio



CIECA LISCIA

- A** Rototraslante reversibile
- C** BIANCO LACCATO
- T** PK ROTO
- M** Linea cromo sat.
- P** Liscio



CIECA LISCIA

- A** Double reversibile*
- C** BIANCO LACCATO
- T** TLS/L8
- M** Linea cromo sat.
- P** Liscio



CERNIERE INVISIBILI AIR 120°

*apertura pieghevole 2/3-1/3



CIECA LISCIA

- A** Scorrevole a scomparsa
- C** BIANCO LACCATO
- T** KLS/L8
- M** Kit L/O Tonda
- P** Liscio



CIECA LISCIA

- A** Scorrevole a scomparsa
- C** BIANCO LACCATO
- T** Binario esterno muro
- M** Kit unghiate Tonda
- P** Liscio



Blindato SICURA

- C** BIANCO LACCATO LISCIO
- T** White

SEZIONE ANTA

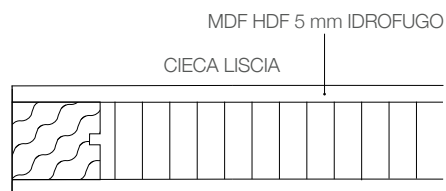

DIMENSIONI TELAI

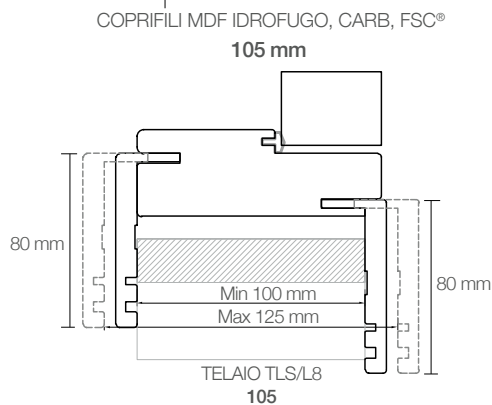
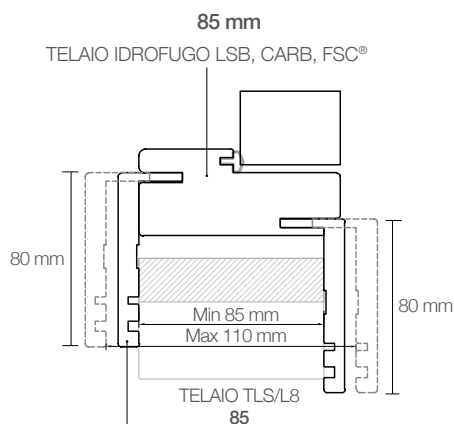

ALLARGAMENTI MURO



DIMENSIONI DISPONIBILI in mm	L	H	T
BATTENTE REVERSIBILE	600/700/750/800/900	2100	85-105
BATTENTE REVERSIBILE 200	700/800	2000	85
SCORREVOLE A SCOMPARSA	600/700/800/900	2100	105-125/90-105
SCORREVOLE ESTERNO MURO	600/700/800/900	2100	-
DOUBLÈ REVERSIBILE	700/800	2100	85
ROTOTRASLANTE REVERSIBILE	700/800	2100	105
BLINDATO	800/900 sx e dx	2100	-



BATTENTE REVERSIBILE
senza ribaltare l'anta

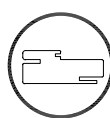

TELAIO TLS
85 MM E 105 MM



SCORREVOLE
ESTERNO MURO



SCORREVOLE
A SCOMPARSA



DOUBLÈ
2/3 - 1/3



ROTOTRASLANTE



SERRATURA MAGNETICA

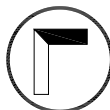

TELAIO 45°

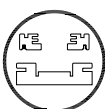

KLS per CASSONETTO
da 105 vuoto 72 → 125 vuoto 90
da 90 vuoto 54



CERNIERE INVISIBILI AIR 120°
a richiesta AIR 180°

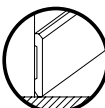

BATTISCOPIA
IN ABBINAMENTO



GUARNIZIONE ACUSTICA

DYNAMIC
BIANCO LACCATO
BATTENTE



DYNAMIC
BIANCO LACCATO
SCORREVOLE A SCOMPARSA



DYNAMIC



DYNAMIC

- A** Battente reversibile
- C** BIANCO LACCATO
- T** TLS/L8
- M** Lime cromo sat.
- P** Inciso



CERNIERE INVISIBILI AIR 120°



DYNAMIC

- A** Scorrevole a scomparsa
- C** BIANCO LACCATO
- T** KLS/L8
- M** Kit L/O Kuader
- P** Inciso



DYNAMIC

- A** Scorrevole a scomparsa
- C** BIANCO LACCATO
- T** Binario esterno muro
- M** Kit unghiate Tonda
- P** Inciso



Blindato SICURA

- C** BIANCO LACCATO LISCIO
 - T** White
- Pannello per porta blindata, solo laccato bianco liscio

SEZIONE ANTA

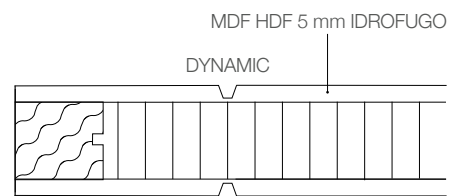

DIMENSIONI TELAI

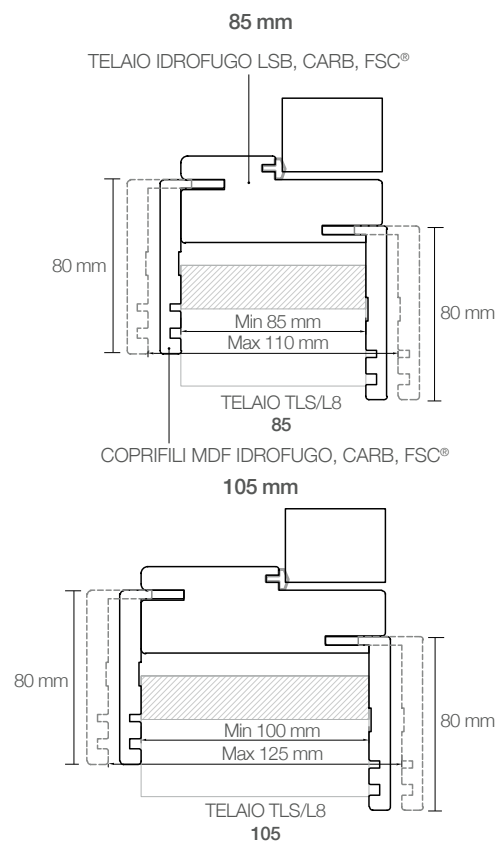

ALLARGAMENTI MURO

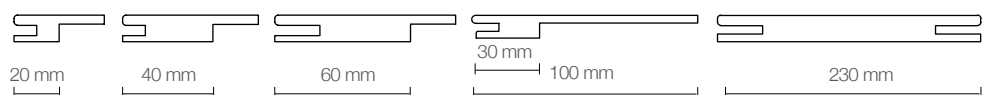

DIMENSIONI DISPONIBILI in mm	L	H	T
BATTENTE REVERSIBILE	600/700/750/800/900	2100	85-105
SCORREVOLE A SCOMPARSA	600/700/800	2100	105-125/90-105
SCORREVOLE ESTERNO MURO	600/700/800	2100	-
BLINDATO	800/900 sx e dx	2100	-



BATTENTE REVERSIBILE
senza ribaltare l'anta

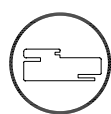

TELAIO TLS
85 MM E 105 MM



SERRATURA MAGNETICA



TELAIO 45°

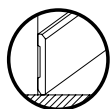

BATTISCOPIA
IN ABBINAMENTO

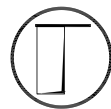

SCORREVOLE
ESTERNO MURO



SCORREVOLE
A SCOMPARSA

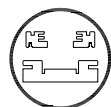

KLS per CASSONETTO
da 105 vuoto 72 → 125 vuoto 90
da 90 vuoto 54



CERNIERE INVISIBILI AIR 120°
a richiesta AIR 180°



GUARNIZIONE ACUSTICA

CROSS
BIANCO LACCATO
BATTENTE



CROSS
BIANCO LACCATO
SCORREVOLE A SCOMPARSA



CROSS



CROSS

- A** Battente reversibile
- C** BIANCO LACCATO
- T** TLS/L8
- M** Lime cromo sat.
- P** Inciso



CERNIERE INVISIBILI AIR 120°

SEZIONE ANTA

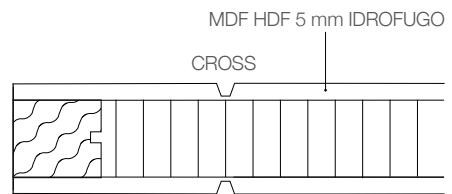

DIMENSIONI TELAI

85 mm

TELAIO IDROFUGO LSB, CARB, FSC®

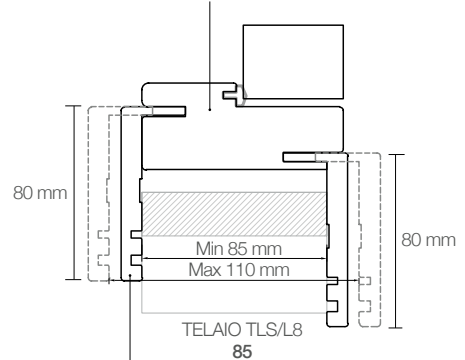

COPRIFILI MDF IDROFUGO, CARB, FSC®

105 mm

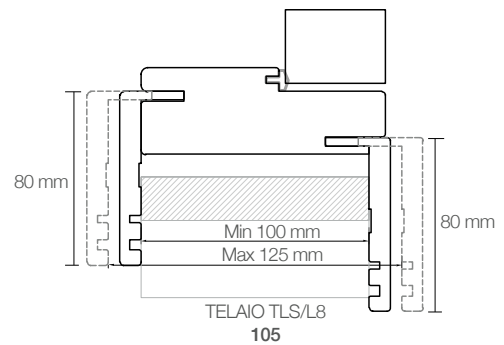

CROSS

- A** Scorrevole a scomparsa
- C** BIANCO LACCATO
- T** KLS/L8
- M** Kit L/O Kuader
- P** Inciso



CROSS

- A** Scorrevole a scomparsa
- C** BIANCO LACCATO
- T** Binario esterno muro
- M** Kit unghiate Tonda
- P** Inciso



Blindato SICURA

- C** BIANCO LACCATO LISCIO
- T** White

Pannello per porta blindata, solo laccato bianco liscio

ALLARGAMENTI MURO

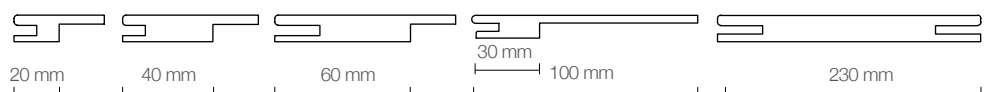

DIMENSIONI DISPONIBILI in mm	L	H	T
BATTENTE REVERSIBILE	600/700/750/800/900	2100	85-105
SCORREVOLE A SCOMPARSA	600/700/800	2100	105-125/90-105
SCORREVOLE ESTERNO MURO	600/700/800	2100	-
BLINDATO	800/900 sx e dx	2100	-



BATTENTE REVERSIBILE
senza ribaltare l'anta

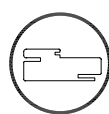

TELAIO TLS
85 MM E 105 MM



SERRATURA MAGNETICA



TELAIO 45°

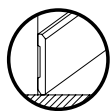

BATTISCOPIA
IN ABBINAMENTO

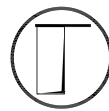

SCORREVOLE
ESTERNO MURO



SCORREVOLE
A SCOMPARSA

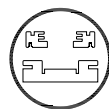

KLS per CASSONETTO
da 105 vuoto 72 → 125 vuoto 90
da 90 vuoto 54



CERNIERE INVISIBILI AIR 120°
a richiesta AIR 180°



GUARNIZIONE ACUSTICA

A photograph of a white, classic-style door with a silver handle and a floor lamp in a room. The door is the central focus, featuring a traditional panel design with a rectangular inset. To the left of the door stands a tall, slender floor lamp with a silver finish and a teardrop-shaped shade. The room has a neutral, light-colored wall and a dark floor. The lighting is soft and even, highlighting the door's details.

CLASSIC
BIANCO LACCATO
BATTENTE



CLASSIC
BIANCO LACCATO
ESTERNO MURO

CLASSIC



CLASSIC

- A** Battente reversibile
- C** BIANCO LACCATO
- T** TLS/L8
- M** Biblo cromo sat.
- P** Pantografato Classic



CERNIERE INVISIBILI AIR 120°



CLASSIC

- A** Scorrevole a scomparsa
- C** BIANCO LACCATO
- T** KLS/L8
- M** Kit L/O Kuader
- P** Pantografato Classic



CLASSIC

- A** Scorrevole esterno muro
- C** BIANCO LACCATO
- T** Binario esterno muro
- M** Kit unghiata Tonda
- P** Pantografato Classic



Blindato SICURA

- C** BIANCO LACCATO LISCIO
- T** White

Pannello per porta blindata, solo laccato bianco liscio

SEZIONE ANTA

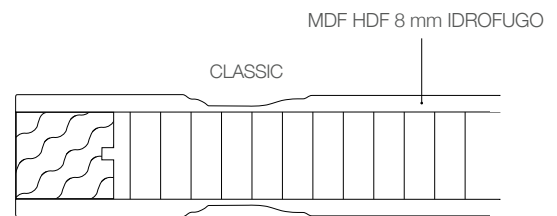

DIMENSIONI TELAI

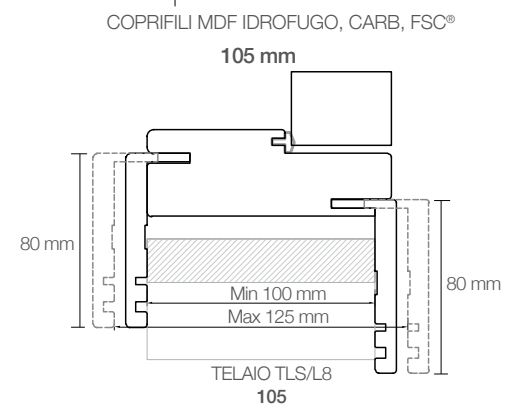
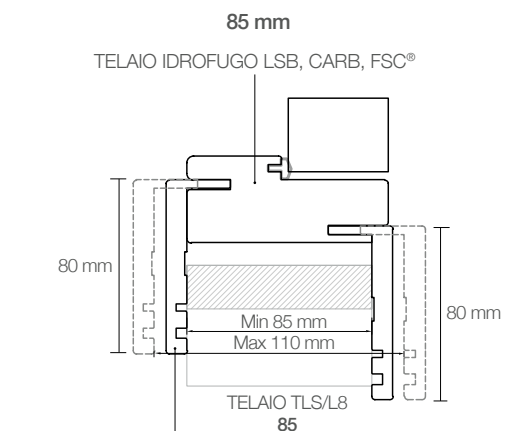

ALLARGAMENTI MURO

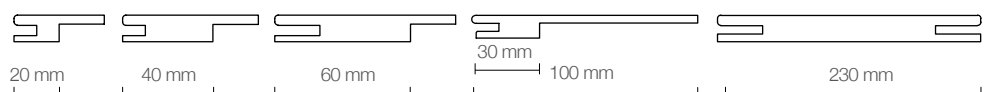

DIMENSIONI DISPONIBILI in mm	L	H	T
BATTENTE REVERSIBILE	600/700/750/800/900	2100	85-105
SCORREVOLE A SCOMPARSA	600/700/800	2100	105-125/90-105
SCORREVOLE ESTERNO MURO	600/700/800	2100	-
BLINDATO	800/900 sx e dx	2100	-



BATTENTE REVERSIBILE
senza ribaltare l'anta

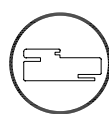

TELAIO TLS
85 MM E 105 MM



SERRATURA MAGNETICA



TELAIO 45°

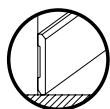

BATTISCOPIA
IN ABBINAMENTO

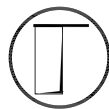

SCORREVOLE
ESTERNO MURO



SCORREVOLE
A SCOMPARSA

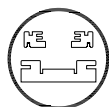

KLS per CASSONETTO
da 105 vuoto 72 → 125 vuoto 90
da 90 vuoto 54



CERNIERE INVISIBILI AIR 120°
a richiesta AIR 180°



GUARNIZIONE ACUSTICA

STYLE
BIANCO LACCATO
BATTENTE





STYLE
BIANCO LACCATO
SCORREVOLE INTERNO MURO



STYLE

- A** Battente reversibile
- C** BIANCO LACCATO
- T** TLS/L8
- M** Biblo cromo sat.
- P** Pantografato Minima



CERNIERE INVISIBILI AIR 120°



STYLE

- A** Scorrevole a scomparsa
- C** BIANCO LACCATO
- T** KLS/L8
- M** Kit L/O Kuader
- P** Pantografato Minima



STYLE

- A** Scorrevole esterno muro
- C** BIANCO LACCATO
- T** Binario esterno muro
- M** Kit unghiata Tonda
- P** Pantografato Minima



Blindato SICURA

- C** BIANCO LACCATO LISCIO
- T** White

Pannello per porta blindata, solo laccato bianco liscio

SEZIONE ANTA

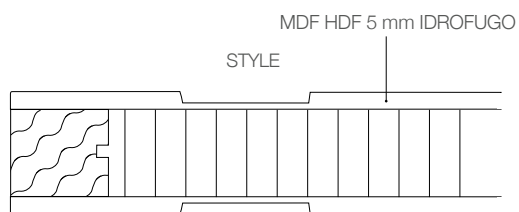

DIMENSIONI TELAI

85 mm

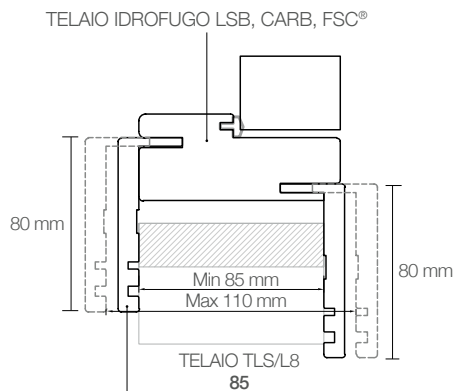

COPRIFILI MDF IDROFUGO, CARB, FSC®
105 mm

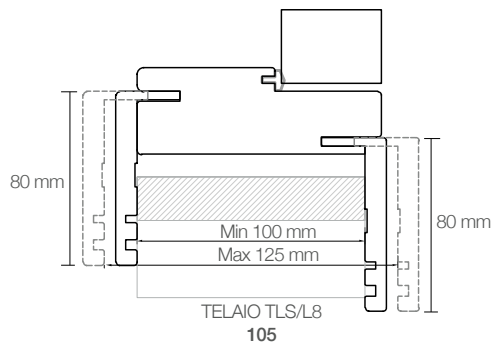

ALLARGAMENTI MURO



DIMENSIONI DISPONIBILI in mm	L	H	T
BATTENTE REVERSIBILE	600/700/750/800/900	2100	85-105
SCORREVOLE A SCOMPARSA	600/700/800/900	2100	105-125/90-105
SCORREVOLE ESTERNO MURO	600/700/800/900	2100	-
BLINDATO	800/900 sx e dx	2100	-



BATTENTE REVERSIBILE
senza ribaltare l'anta

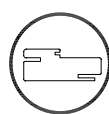

TELAIO TLS
85 MM E 105 MM



SERRATURA MAGNETICA



TELAIO 45°

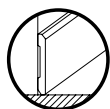

BATTISCOPIA
IN ABBINAMENTO

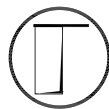

SCORREVOLE
ESTERNO MURO



SCORREVOLE
A SCOMPARSA

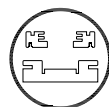

KLS per CASSONETTO
da 105 vuoto 72 → 125 vuoto 90
da 90 vuoto 54



CERNIERE INVISIBILI AIR 120°
a richiesta AIR 180°



GUARNIZIONE ACUSTICA



TRENDY
BIANCO LACCATO
BATTENTE



TRENDY
BIANCO LACCATO
BATTENTE

TRENDY



TRENDY

- A** Battente reversibile
- C** BIANCO LACCATO
- T** TLS/L8
- M** Biblo cromo sat.
- P** Pantografato Minima



CERNIERE INVISIBILI AIR 120°



TRENDY

- A** Scorrevole a scomparsa
- C** BIANCO LACCATO
- T** KLS/L8
- M** Kit L/O Kuader
- P** Pantografato Minima



TRENDY

- A** Scorrevole esterno muro
- C** BIANCO LACCATO
- T** Binario esterno muro
- M** Kit unghiate Tonda
- P** Pantografato Minima



Blindato SICURA

- C** BIANCO LACCATO LISCIO
- T** White

Pannello per porta blindata, solo laccato bianco liscio

SEZIONE ANTA

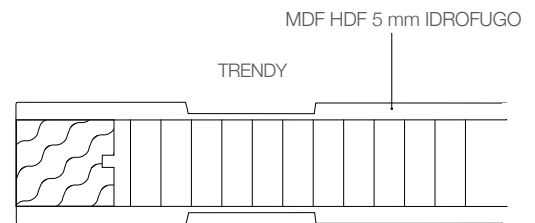

DIMENSIONI TELAI

85 mm

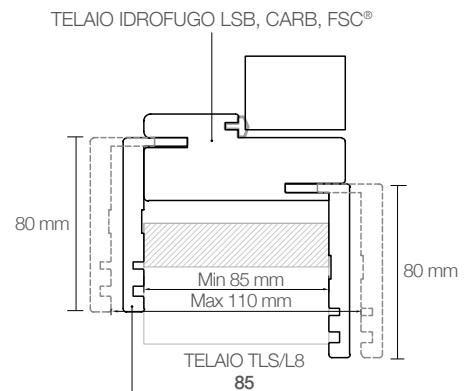

COPRIFILI MDF IDROFUGO, CARB, FSC®

105 mm

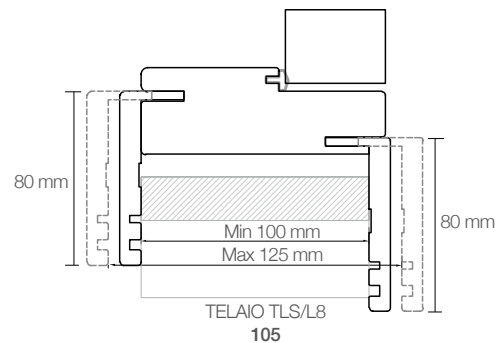

ALLARGAMENTI MURO

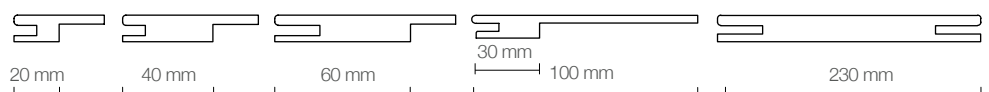

DIMENSIONI DISPONIBILI in mm	L	H	T
BATTENTE REVERSIBILE	600/700/750/800/900	2100	85-105
SCORREVOLE A SCOMPARSA	600/700/800	2100	105-125/90-105
SCORREVOLE ESTERNO MURO	600/700/800	2100	
BLINDATO	800/900 sx e dx	2100	



BATTENTE REVERSIBILE
senza ribaltare l'anta

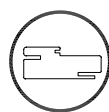

TELAIO TLS
85 MM E 105 MM



SERRATURA MAGNETICA



TELAIO 45°

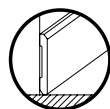

BATTISCOPIA
IN ABBINAMENTO

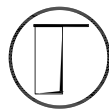

SCORREVOLE
ESTERNO MURO



SCORREVOLE
A SCOMPARSA

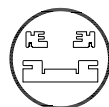

KLS per CASSONETTO
da 105 vuoto 72 → 125 vuoto 90
da 90 vuoto 54



CERNIERE INVISIBILI AIR 120°
a richiesta AIR 180°



GUARNIZIONE ACUSTICA

BIANCO MATRIX
SCORREVOLE A SCOMPARSA





BIANCO MATRIX
BATTENTE

BIANCO MATRIX



BIANCO MATRIX

- A** Battente reversibile
- C** BIANCO MATRIX
- T** TLS-A/L8
- M** Biblo cromo sat.
- P** Venatura orizzontale



BIANCO MATRIX

- A** Rototraslante reversibile
- C** BIANCO MATRIX
- T** PK ROTO
- M** Biblo cromo sat.
- P** Venatura orizzontale



BIANCO MATRIX

- A** Piego reversibile
- C** BIANCO MATRIX
- T** TLS-A/L8
- M** Kit L/O Tonda
- P** Venatura orizzontale



CERNIERE ANUBA REVERSIBILI MONO GAMBO



BIANCO MATRIX

- A** Scorrevole a scomparsa
- C** BIANCO MATRIX
- T** KLS/L8
- M** Kit L/O Tonda
- P** Venatura orizzontale



BIANCO MATRIX

- A** Scorrevole esterno muro
- C** BIANCO MATRIX
- T** Binario esterno muro
- M** Kit unghiata Tonda
- P** Venatura orizzontale



Blindato SICURA

- C** BIANCO MATRIX
- T** White

DIMENSIONI TELAI

85 mm

TELAIO LSB IDROFUGO, CARB, FSC®

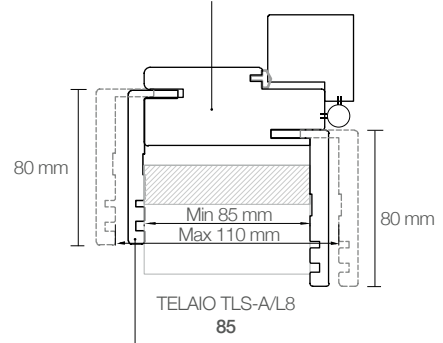

COPRIFILI CARB, FSC®

105 mm

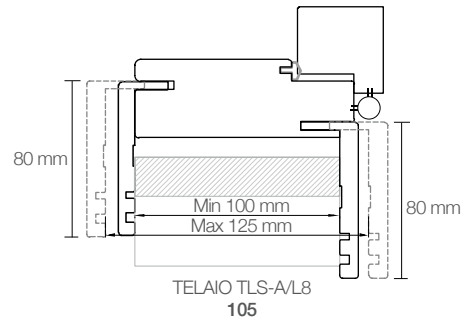

ALLARGAMENTI MURO

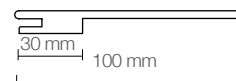

DIMENSIONI DISPONIBILI in mm	L	H	T
BATTENTE REVERSIBILE	600/700/800/900	2100	85-105
BATTENTE REVERSIBILE 200	600/700/800/900	2000	85
SCORREVOLE A SCOMPARSA	600/700/800/900	2100	105-125
SCORREVOLE ESTERNO MURO	600/700/800/900	2100	-
ROTOTRASLANTE REVERSIBILE	700/800	2100	105
PIEGO REVERSIBILE	700/800	2100	85
BLINDATO	800/900 sx e dx	2100	-

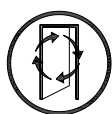

BATTENTE REVERSIBILE
ribaltando l'anta

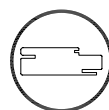

TELAIO TLS-A
85 MM E 105 MM



KIT ANGOLARI
FERMAPANNELLO

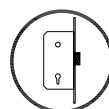

SERRATURA MEDIANA

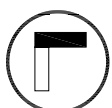

TELAIO 90°

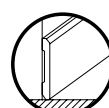

BATTISCOPIA
IN ABBINAMENTO



SCORREVOLE
ESTERNO MURO



SCORREVOLE
A SCOMPARSA

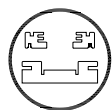

KLS per CASSONETTO
da 105 vuoto 72 → 125 vuoto 90

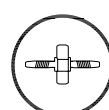

CERNIERE ANUBA
REVERSIBILI



GUARNIZIONE ACUSTICA

BIANCO MATRIX VETRO
BATTENTE



BIANCO MATRIX VETRO
SCORREVOLE A SCOMPARSA



BIANCO MATRIX



BIANCO MATRIX VETRO

- A Battente reversibile
- C BIANCO MATRIX
- T TLS-A/L8
- M Biblo cromo sat.
- V Bianco latte 3+3



CERNIERE ANUBA REVERSIBILI MONO GAMBO



BIANCO MATRIX VETRO

- A Scorrevole a scomparsa
- C BIANCO MATRIX
- T KLS/L8
- M Kit L/O Tonda
- V Bianco latte 3+3



BIANCO MATRIX VETRO

- A Scorrevole esterno muro
- C BIANCO MATRIX
- T Binario esterno muro
- M Kit unghiata Tonda
- P Liscio



Blindato SICURA

- C BIANCO MATRIX
- T White

DIMENSIONI TELAI

85 mm

TELAIO LSB IDROFUGO, CARB, FSC®

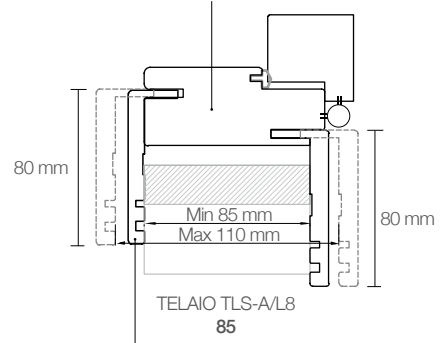

105 mm

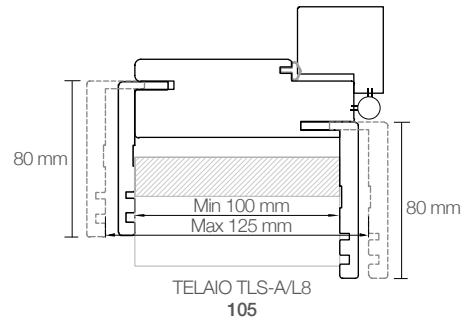

ALLARGAMENTI MURO

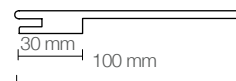

DIMENSIONI DISPONIBILI in mm	L	H	T
BATTENTE REVERSIBILE	600/700/800/900	2100	85-105
SCORREVOLE A SCOMPARSA	700/800	2100	105-125
SCORREVOLE ESTERNO MURO	700/800	2100	-
BLINDATO	800/900 sx e dx	2100	-



BATTENTE REVERSIBILE
ribaltando l'anta

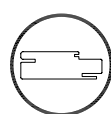

TELAIO TLS-A
85 MM E 105 MM



KIT ANGOLARI
FERMAPANNELLO

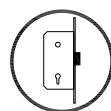

SERRATURA MEDIANA

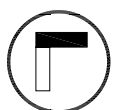

TELAIO 90°

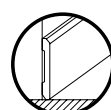

BATTISCOPA
IN ABBINAMENTO



SCORREVOLE
ESTERNO MURO

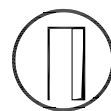

SCORREVOLE
A SCOMPARSA

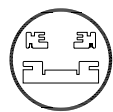

KLS per CASSONETTO
da 105 vuoto 72 → 125 vuoto 90

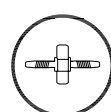

CERNIERE ANUBA
REVERSIBILI



GUARNIZIONE ACUSTICA

AVENA MATRIX
BATTENTE





AVENA MATRIX VETRO
SCORREVOLE A SCOMPARSA

AVENA MATRIX - AVENA MATRIX VETRO



AVENA MATRIX

- A** Battente reversibile
- C** AVENA MATRIX
- T** TLS-A/L8
- M** Biblo cromo sat.
- P** Venatura orizzontale



AVENA MATRIX

- A** Scorrevole a scomparsa
- C** AVENA MATRIX
- T** KLS/L8
- M** Kit L/O Kuader
- P** Venatura orizzontale



CERNIERE ANUBA REVERSIBILI MONO GAMBO



AVENA MATRIX VETRO

- A** Battente reversibile
- C** AVENA MATRIX
- T** TLS-A/L8
- M** Biblo cromo sat.
- V** Bianco latte 3+3



AVENA MATRIX VETRO

- A** Scorrevole a scomparsa
- C** AVENA MATRIX
- T** KLS/L8
- M** Kit L/O Tonda
- V** Bianco latte 3+3



Blindato SICURA

- C** AVENA MATRIX
- T** Silver

DIMENSIONI TELAI

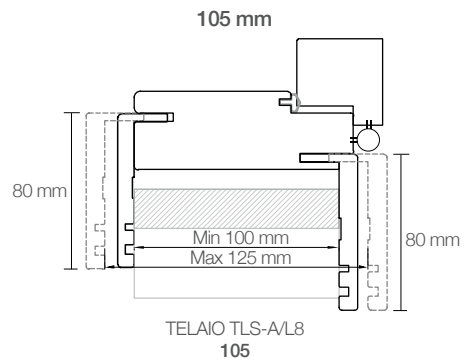
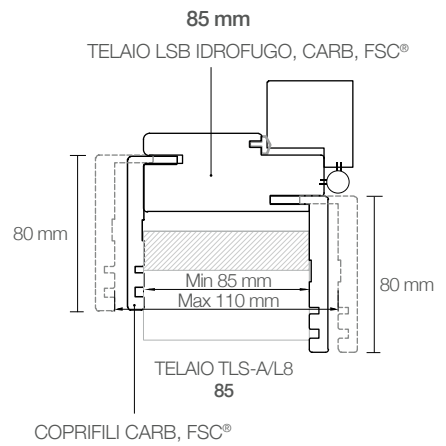

ALLARGAMENTI MURO

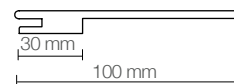

DIMENSIONI DISPONIBILI in mm	L	H	T
BATTENTE REVERSIBILE	600/700/800/900	2100	85-105
SCORREVOLE A SCOMPARSA	700/800	2100	105-125
BLINDATO	800/900 sx e dx	2100	-



BATTENTE REVERSIBILE
ribaltando l'anta

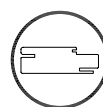

TELAIO TLS-A
85 MM E 105 MM



KIT ANGOLARI
FERMAPANNELLO

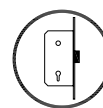

SERRATURA MEDIANA

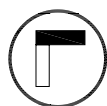

TELAIO 90°

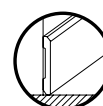

BATTISCOPA
IN ABBINAMENTO



SCORREVOLE
ESTERNO MURO



SCORREVOLE
A SCOMPARSA

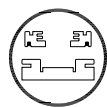

KLS per CASSONETTO
da 105 vuoto 72 → 125 vuoto 90

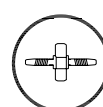

CERNIERE ANUBA
REVERSIBILI



GUARNIZIONE ACUSTICA

CALCE
BATTENTE



CALCE
ROTOTRASLANTE



CALCE



CALCE

- A** Battente reversibile
- C** CALCE
- T** TLS/L8
- M** Biblo cromo sat.
- P** Effetto spatolato



CALCE

- A** Rototraslante reversibile
- C** CALCE
- T** PK ROTO
- M** Biblo cromo sat.
- P** Effetto spatolato



CERNIERE INVISIBILI AIR 120°



CALCE

- A** Scorrevole a scomparsa
- C** CALCE
- T** KLS/L8
- M** Kit L/O Kuader
- P** Effetto spatolato



Blindato SICURA

- C** CALCE
- T** Silver

DIMENSIONI TELAI

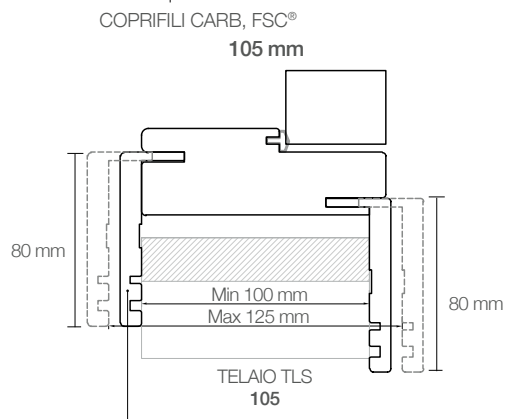
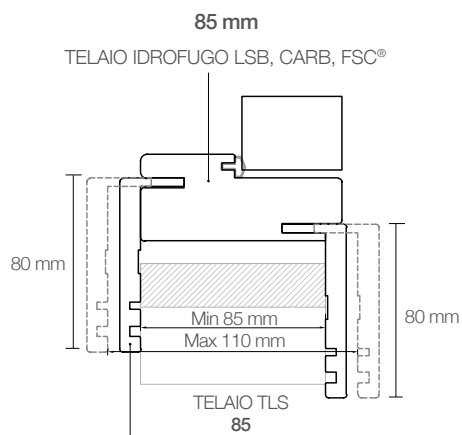

ALLARGAMENTI MURO

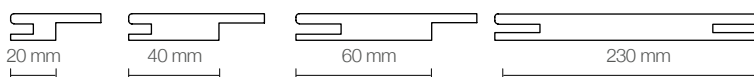

DIMENSIONI DISPONIBILI in mm	L	H	T
BATTENTE REVERSIBILE	600/700/750/800/900	2100	85-105
SCORREVOLE A SCOMPARSA	600/700/800/900	2100	105-125/90-105
ROTOTRASLANTE REVERSIBILE	700/800	2100	105
BLINDATO	800/900 sx e dx	2100	-



BATTENTE REVERSIBILE
senza ribaltare l'anta

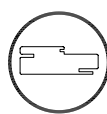

TELAIO TLS
85 MM E 105 MM



SERRATURA MAGNETICA



TELAIO 45°

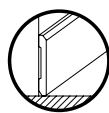

BATTISCOPIA
IN ABBINAMENTO

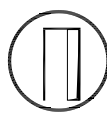

SCORREVOLE
A SCOMPARSA

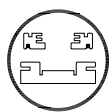

KLS per CASSONETTO
da 105 vuoto 72 → 125 vuoto 90
da 90 vuoto 54

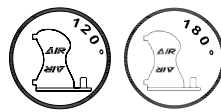

CERNIERE INVISIBILI
AIR 120°
a richiesta AIR 180°



GUARNIZIONE ACUSTICA

BIANCO STRUTTURA
BATTENTE



BIANCO STRUTTURA
SCORREVOLE A SCOMPARSA



BIANCO STRUTTURA



BIANCO STRUTTURA

- A** Battente reversibile
- C** BIANCO STRUTTURA
- T** TLS/L8
- M** Biblo cromo sat.
- P** Venatura orizzontale



CERNIERE INVISIBILI AIR 120°



BIANCO STRUTTURA

- A** Scorrevole a scomparsa
- C** BIANCO STRUTTURA
- T** KLS/L8
- M** Kit L/O Tonda
- P** Venatura orizzontale



BIANCO STRUTTURA

- A** Scorrevole esterno muro
- C** BIANCO STRUTTURA
- T** Binario esterno muro
- M** Kit unghiata Tonda
- P** Venatura orizzontale



Blindato SICURA

- C** BIANCO STRUTTURA
- T** Silver

DIMENSIONI TELAI

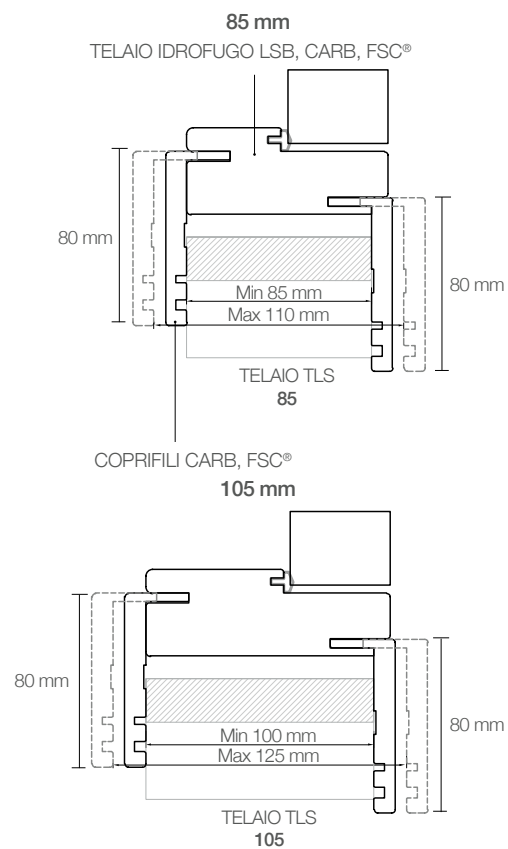

ALLARGAMENTI MURO

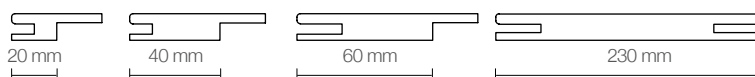

DIMENSIONI DISPONIBILI in mm	L	H	T
BATTENTE REVERSIBILE	600/700/750/800/900	2100	85-105
SCORREVOLE A SCOMPARSA	700/800	2100	105-125/90-105
SCORREVOLE ESTERNO MURO	700/800	2100	-
BLINDATO	800/900 sx e dx	2100	-



BATTENTE REVERSIBILE
senza ribaltare l'anta

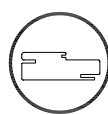

TELAIO TLS
85 MM E 105 MM



SERRATURA MAGNETICA



TELAIO 45°

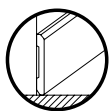

BATTISCOPIA
IN ABBINAMENTO

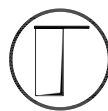

SCORREVOLE
ESTERNO MURO



SCORREVOLE
A SCOMPARSA

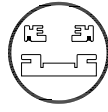

KLS per CASSONETTO
da 105 vuoto 72 → 125 vuoto 90
da 90 vuoto 54



CERNIERE INVISIBILI AIR 120°
a richiesta AIR 180°



GUARNIZIONE ACUSTICA



RISO
BATTENTE



RISO
SCORREVOLE A SCOMPARSA



RISO

- A** Battente reversibile
- C** RISO
- T** TK/L8
- M** Biblo cromo sat.
- P** Venatura orizzontale



CERNIERE INVISIBILI AIR 120°



RISO

- A** Scorrevole a scomparsa
- C** RISO
- T** KSK/L8
- M** Kit L/O Kuader
- P** Venatura orizzontale



Blindato SICURA

- C** RISO
- T** Silver

DIMENSIONI TELAI

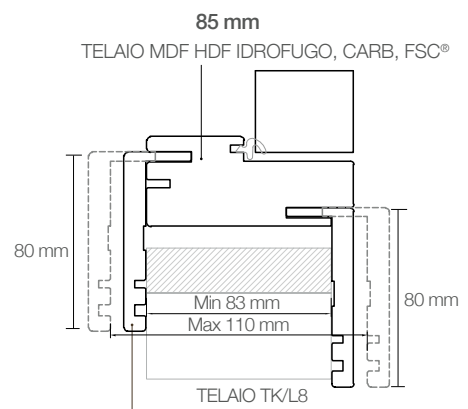

85
COPRIFILI MDF IDROFUGO, CARB, FSC®

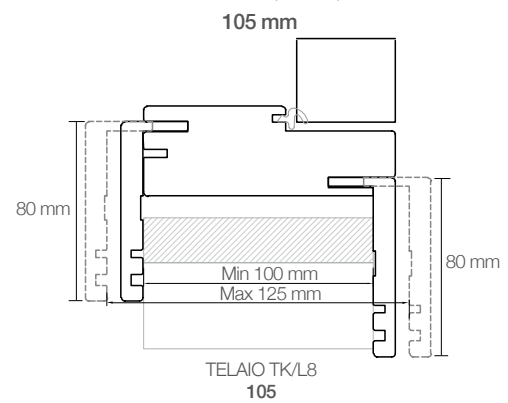

ALLARGAMENTI MURO



DIMENSIONI DISPONIBILI in mm	L	H	T
BATTENTE REVERSIBILE	600/700/750/800/900	2100	85-105
SCORREVOLE A SCOMPARSA	700/800	2100	105-125/90-105
BLINDATO	800/900 sx e dx	2100	-



BATTENTE REVERSIBILE
senza ribaltare l'anta

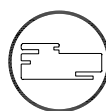

TELAIO TK
85 MM E 105 MM



SERRATURA MAGNETICA

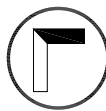

TELAIO 45°

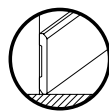

BATTISCOPIA
IN ABBINAMENTO



SCORREVOLE
A SCOMPARSA

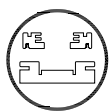

KSK per CASSONETTO
da 105 vuoto 72 → 125 vuoto 90
da 90 vuoto 54

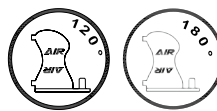

CERNIERE INVISIBILI AIR 120°
a richiesta AIR 180°



GUARNIZIONE ACUSTICA



ORZO
BATTENTE



ORZO
SCORREVOLE A SCOMPARSA



ORZO

- A** Battente reversibile
- C** ORZO
- T** TK/L8
- M** Biblo cromo sat.
- P** Venatura orizzontale



CERNIERE INVISIBILI AIR 120°



ORZO

- A** Scorrevole a scomparsa
- C** ORZO
- T** KSK/L8
- M** Kit L/O Kuader
- P** Venatura orizzontale



Blindato SICURA

- C** ORZO
- T** Silver

DIMENSIONI TELAI

85 mm

TELAIO MDF HDF IDROFUGO, CARB, FSC®

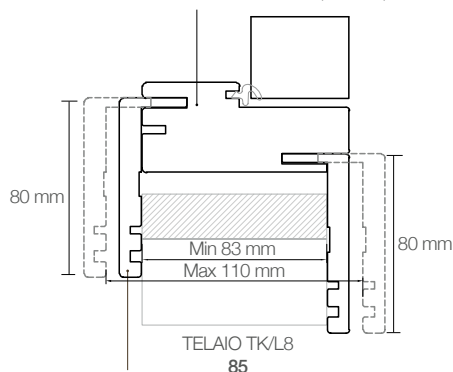

COPRIFILI MDF IDROFUGO, CARB, FSC®

105 mm

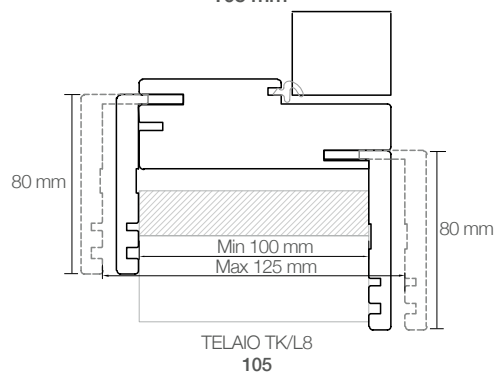

ALLARGAMENTI MURO



DIMENSIONI DISPONIBILI in mm	L	H	T
BATTENTE REVERSIBILE	600/700/750/800/900	2100	85-105
SCORREVOLE A SCOMPARSA	700/800	2100	105-125/90-105
BLINDATO	800/900 sx e dx	2100	-



BATTENTE REVERSIBILE
senza ribaltare l'anta

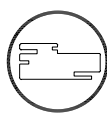

TELAIO TK
85 MM E 105 MM



SERRATURA MAGNETICA



TELAIO 45°

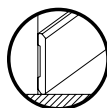

BATTISCOPIA
IN ABBINAMENTO

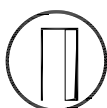

SCORREVOLE
A SCOMPARSA

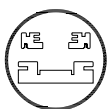

KSK per CASSONETTO
da 105 vuoto 72 → 125 vuoto 90
da 90 vuoto 54



CERNIERE INVISIBILI AIR 120°
a richiesta AIR 180°



GUARNIZIONE ACUSTICA



FARRO
SCORREVOLE A SCOMPARSA



FARRO
BATTENTE

FARRO



FARRO

- A** Battente reversibile
- C** FARRO
- T** TK/L8
- M** Biblo cromo sat.
- P** Venatura orizzontale



CERNIERE INVISIBILI AIR 120°



FARRO

- A** Scorrevole a scomparsa
- C** FARRO
- T** KSK/L8
- M** Kit L/O Kuader
- P** Venatura orizzontale



Blindato SICURA

- C** FARRO
- T** Silver

DIMENSIONI TELAI

85 mm

TELAIO MDF HDF IDROFUGO, CARB, FSC®

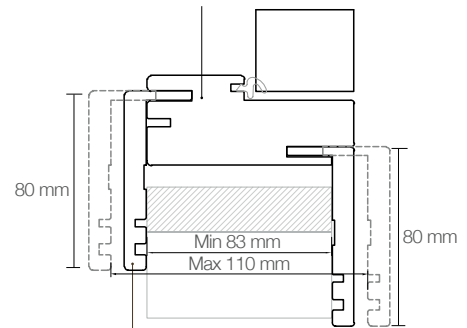

85

COPRIFILI MDF IDROFUGO, CARB, FSC®

105 mm

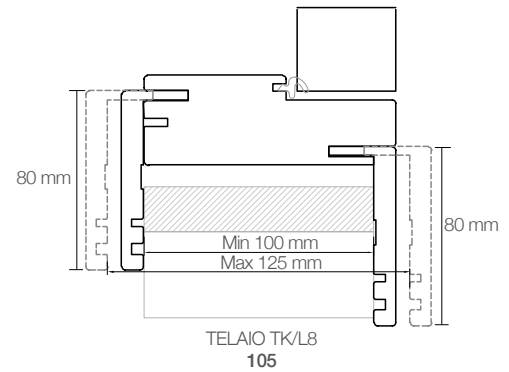

105

ALLARGAMENTI MURO



DIMENSIONI DISPONIBILI in mm	L	H	T
BATTENTE REVERSIBILE	600/700/750/800/900	2100	85-105
SCORREVOLE A SCOMPARSA	700/800	2100	105-125/90-105
BLINDATO	800/900 sx e dx	2100	-



BATTENTE REVERSIBILE
senza ribaltare l'anta

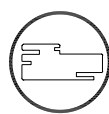

TELAIO TK
85 MM E 105 MM



SERRATURA MAGNETICA



TELAIO 45°

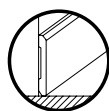

BATTISCOPA
IN ABBINAMENTO



SCORREVOLE
A SCOMPARSA

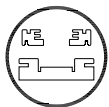

KSK per CASSONETTO
da 105 vuoto 72 → 125 vuoto 90
da 90 vuoto 54

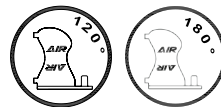

CERNIERE INVISIBILI AIR 120°
a richiesta AIR 180°



GUARNIZIONE ACUSTICA

BIANCO HD VETRO
BATTENTE





BIANCO HD
BATTENTE

BIANCO HD - BIANCO HD VETRO



BIANCO HD

- A** Battente reversibile
- C** BIANCO HD*
- T** TK/L8
- M** Lime cromo sat.
- P** Liscio



BIANCO HD

- A** Scorrevole a scomparsa
- C** BIANCO HD*
- T** KSK/L8
- M** Kit L/O Kuader
- P** Liscio



BIANCO HD

- A** Scorrevole esterno muro
- C** BIANCO HD*
- T** Binario esterno muro
- M** Kit unghiata Tonda
- P** Liscio



CERNIERE INVISIBILI AIR 120°

*BIANCO HD = LAMINATO CPL



BIANCO HD VETRO

- A** Battente reversibile
- C** BIANCO HD*
- T** TK/L8
- M** Biblo cromo sat.
- V** Bianco latte 3+3



BIANCO HD VETRO

- A** Scorrevole a scomparsa
- C** BIANCO HD*
- T** KSK/L8
- M** Kit unghiata L/O Kuader
- V** Bianco latte 3+3



BIANCO HD VETRO

- A** Scorrevole esterno muro
- C** BIANCO HD*
- T** Binario esterno muro
- M** Kit unghiata Tonda
- V** Bianco latte 3+3

DIMENSIONI TELAI

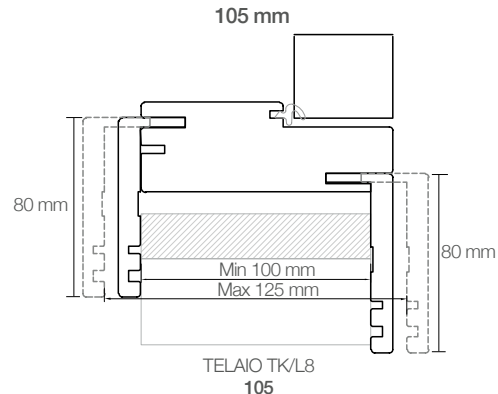
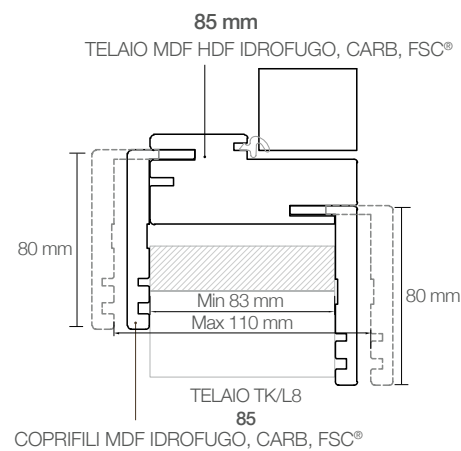

Blindato SICURA

- C** BIANCO HD
- T** White

ALLARGAMENTI MURO



DIMENSIONI DISPONIBILI in mm	L	H	T
BATTENTE REVERSIBILE	600/700/750/800/900	2100	85-105
VETRO BATTENTE REVERSIBILE	600/700/800/900	2100	85-105
SCORREVOLE A SCOMPARSA	700/800	2100	105-125/90-105
SCORREVOLE ESTERNO MURO	700/800	2100	-
BLINDATO	800/900 sx e dx	2100	-



BATTENTE REVERSIBILE
senza ribaltare l'anta

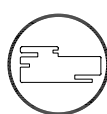

TELAIO TK
85 MM E 105 MM



SERRATURA MAGNETICA



TELAIO 45°

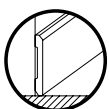

BATTISCOPIA
IN ABBINAMENTO



SCORREVOLE
ESTERNO MURO

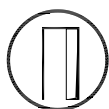

SCORREVOLE
A SCOMPARSA

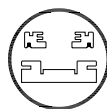

KSK per CASSONETTO
da 105 vuoto 72 → 125 vuoto 90
da 90 vuoto 54



CERNIERE INVISIBILI AIR 120°
a richiesta AIR 180°



GUARNIZIONE ACUSTICA

NOCE NAZIONALE
BATTENTE





NOCE NAZIONALE VETRO
SCORREVOLE A SCOMPARSA

NOCE NAZIONALE - NOCE NAZIONALE VETRO



NOCE NAZIONALE

- A** Battente reversibile
- C** NOCE NAZIONALE
- T** TK/L8
- M** Linea oro lucido
- P** Venatura verticale



NOCE NAZIONALE

- A** Scorrevole a scomparsa
- C** NOCE NAZIONALE
- T** KSK/L8
- M** Kit L/O Kuader
- P** Venatura verticale



CERNIERE INVISIBILI AIR 120°



NOCE NAZIONALE VETRO

- A** Battente reversibile
- C** NOCE NAZIONALE
- T** TK/L8
- M** Biblo cromo sat.
- V** Bianco latte 3+3



NOCE NAZIONALE VETRO

- A** Scorrevole a scomparsa
- C** NOCE NAZIONALE
- T** KSK/L8
- M** Kit L/O Kuader
- V** Bianco latte 3+3



Blindato SICURA

- C** NOCE NAZIONALE
- T** Black

DIMENSIONI TELAI

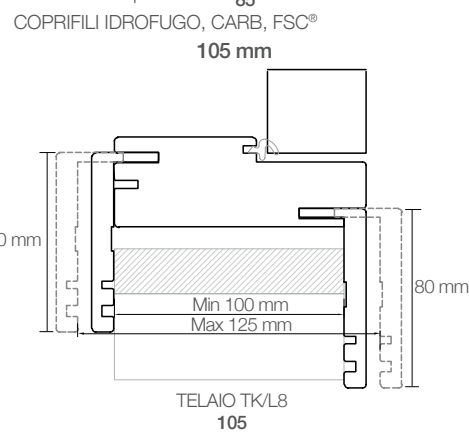
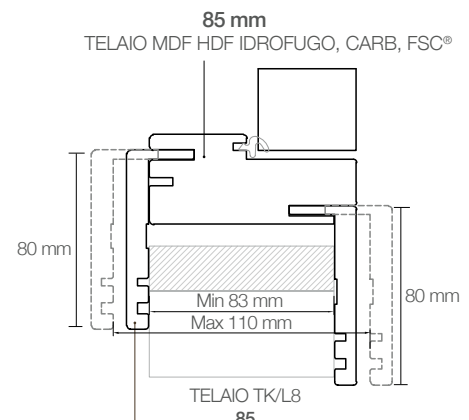

ALLARGAMENTI MURO



DIMENSIONI DISPONIBILI in mm	L	H	T
BATTENTE REVERSIBILE	600/700/750/800/900	2100	85-105
VETRO BATTENTE REVERSIBILE	600/700/800/900	2100	85-105
SCORREVOLE A SCOMPARSA	700/800	2100	105-125/90-105
BLINDATO	800/900 sx e dx	2100	-



BATTENTE REVERSIBILE
senza ribaltare l'anta

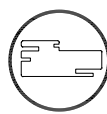

TELAIO TK
85 MM E 105 MM



SERRATURA MAGNETICA



TELAIO 45°

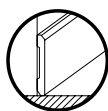

BATTISCOPIA
IN ABBINAMENTO



SCORREVOLE
A SCOMPARSA

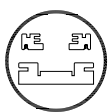

KSK per CASSONETTO
da 105 vuoto 72 → 125 vuoto 90
da 90 vuoto 54



CERNIERE INVISIBILI AIR 120°
a richiesta AIR 180°



GUARNIZIONE ACUSTICA

LATTE
BATTENTE



LATTE
SCORREVOLE A SCOMPARSA



LATTE



LATTE

- A** Battente reversibile
- C** LATTE
- T** TP/L6
- M** Linea cromo sat.
- P** Venatura verticale



CERNIERE ANUBA REVERSIBILI MONO GAMBO



LATTE

- A** Scorrevole a scomparsa
- C** LATTE
- T** KSV/L6
- M** Kit L/O Kuader
- P** Venatura verticale



Blindato SICURA

- C** LATTE
- T** Silver

DIMENSIONI TELAI

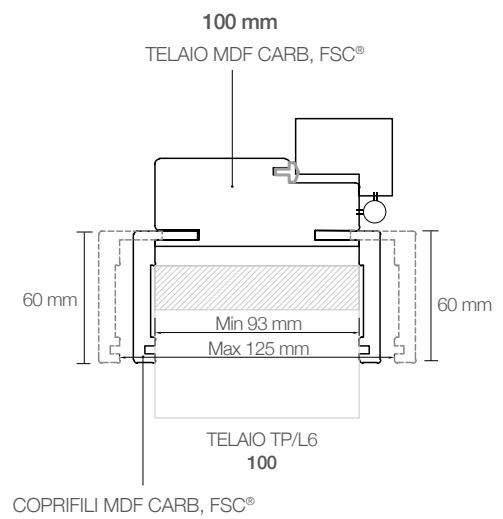

ALLARGAMENTI MURO

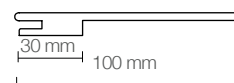

DIMENSIONI DISPONIBILI in mm	L	H	T
BATTENTE REVERSIBILE	600/700/800/900	2100	100
SCORREVOLE A SCOMPARSA	700/800	2100	105-125
BLINDATO	800/900 sx e dx	2100	-



BATTENTE REVERSIBILE
ribaltando l'anta

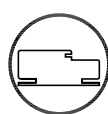

TELAIO TP/L6
100 MM

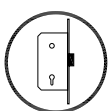

SERRATURA MEDIANA



TELAIO 90°

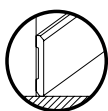

BATTISCOPIA
IN ABBINAMENTO



SCORREVOLE
A SCOMPARSA

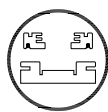

KSV/L6 per CASSONETTO
da 105 vuoto 72 → 125 vuoto 90

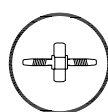

CERNIERE ANUBA
REVERSIBILI



GUARNIZIONE ACUSTICA

CORDA
BATTENTE



CORDA
SCORREVOLE A SCOMPARSA



CORDA



CORDA

- A** Battente reversibile
- C** CORDA
- T** TP/L6
- M** Linea cromo sat.
- P** Venatura verticale



CERNIERE ANUBA REVERSIBILI MONO GAMBO



CORDA

- A** Scorrevole a scomparsa
- C** CORDA
- T** KSV/L6
- M** Kit L/O Kuader
- P** Venatura verticale



Blindato SICURA

- C** CORDA
- T** Silver

DIMENSIONI TELAI

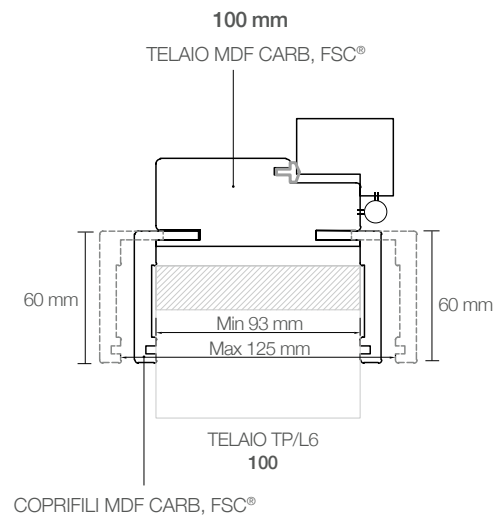

ALLARGAMENTI MURO

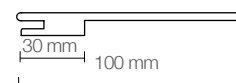

DIMENSIONI DISPONIBILI in mm	L	H	T
BATTENTE REVERSIBILE	600/700/800/900	2100	100
SCORREVOLE A SCOMPARSA	700/800	2100	105-125
BLINDATO	800/900 sx e dx	2100	-

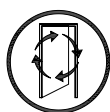

BATTENTE REVERSIBILE
ribaltando l'anta

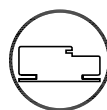

TELAIO TP/L6
100 MM

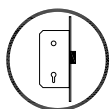

SERRATURA MEDIANA



TELAIO 90°



BATTISCOPIA
NON DISPONIBILE

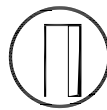

SCORREVOLE
A SCOMPARSA

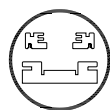

KSV/L6 per CASSONETTO
da 105 vuoto 72 → 125 vuoto 90

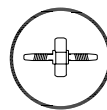

CERNIERE ANUBA
REVERSIBILI



GUARNIZIONE ACUSTICA

QUADRA BIANCO
BATTENTE



QUADRA BIANCO
SCORREVOLE A SCOMPARSA



QUADRA BIANCO



QUADRA BIANCO

- A** Battente reversibile
- C** BIANCO MICRO
- T** TP/L6
- M** Linea cromo sat.
- P** Liscio



CERNIERE ANUBA REVERSIBILI MONO GAMBO



QUADRA BIANCO

- A** Scorrevole a scomparsa
- C** BIANCO MICRO
- T** KSV/L6
- M** Kit L/O Kuader
- P** Liscio



Blindato SICURA

- C** BIANCO MICRO
- T** White

DIMENSIONI TELAI

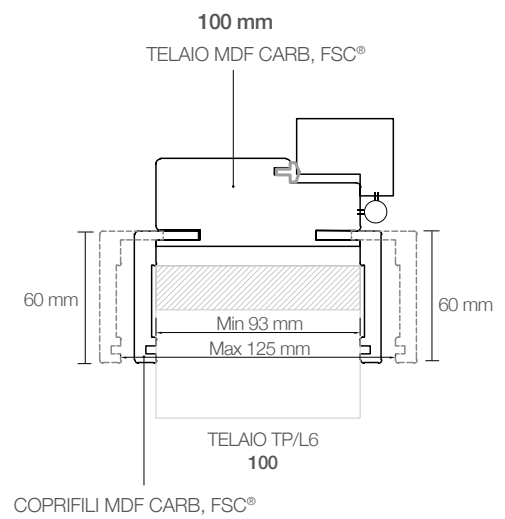

ALLARGAMENTI MURO

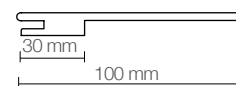

DIMENSIONI DISPONIBILI in mm	L	H	T
BATTENTE REVERSIBILE	600/700/800/900	2100	100
SCORREVOLE A SCOMPARSA	700/800	2100	105-125
BLINDATO	800/900 sx e dx	2100	-

NOTA TECNICA = PER PORTA SCORREVOLE ESTERNO MURO VEDI TONDA BIANCO A PAG. 96



BATTENTE REVERSIBILE
ribaltando l'anta

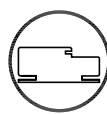

TELAIO TP/L6
100 MM

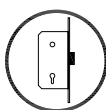

SERRATURA MEDIANA

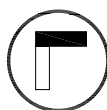

TELAIO 90°



BATTISCOPIA
NON DISPONIBILE

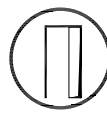

SCORREVOLE
A SCOMPARSA

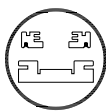

KSV/L6 per CASSONETTO
da 105 vuoto 72 → 125 vuoto 90

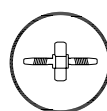

CERNIERE ANUBA
REVERSIBILI



GUARNIZIONE ACUSTICA

BAND
BATTENTE



BAND
SCORREVOLE A SCOMPARSA



BAND



BAND

- A** Battente reversibile
- C** BIANCO MICRO
- T** TP/L6
- M** Linea cromo sat.
- P** Liscio



CERNIERE ANUBA REVERSIBILI MONO GAMBO



BAND

- A** Scorrevole a scomparsa
- C** BIANCO MICRO
- T** KSV/L6
- M** Kit L/O Kuader
- P** Liscio



Blindato SICURA

- C** BIANCO MICRO
- T** White

DIMENSIONI TELAI

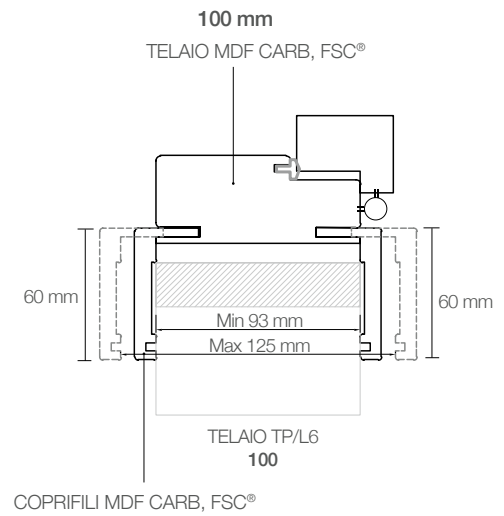

ALLARGAMENTI MURO

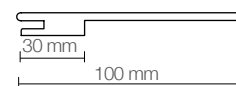

DIMENSIONI DISPONIBILI in mm	L	H	T
BATTENTE REVERSIBILE	600/700/800/900	2100	100
SCORREVOLE A SCOMPARSA	700/800	2100	105-125
SCORREVOLE ESTERNO MIURO	700/800	2100	-
BLINDATO	800/900 sx e dx	2100	-

NOTA TECNICA = PER PORTA SCORREVOLE ESTERNO MURO VEDI TONDA BIANCO A PAG. 96



BATTENTE REVERSIBILE
ribaltando l'anta

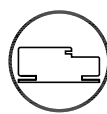

TELAIO TP/L6
100 MM

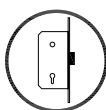

SERRATURA MEDIANA

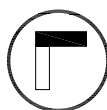

TELAIO 90°

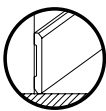

BATTISCOPIA
IN ABBINAMENTO

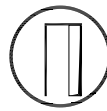

SCORREVOLE
A SCOMPARSA

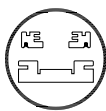

KSV/L6 per CASSONETTO
da 105 vuoto 72 → 125 vuoto 90

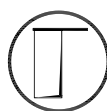

SCORREVOLE
ESTERNO MURO



GUARNIZIONE ACUSTICA

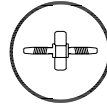

CERNIERE ANUBA
REVERSIBILI

TONDA ECRÙ
SCORREVOLE A SCOMPARSA



TONDA ECRÙ
BATTENTE



TONDA ECRÙ



TONDA ECRÙ

- A** Battente reversibile
- C** ECRÙ
- T** TV/V7
- M** Goccia cromo sat.
- P** Venatura orizzontale



TONDA ECRÙ

- A** Piègo reversibile
- C** ECRÙ
- T** TV/V7
- M** Kit L/O Tonda
- P** Venatura orizzontale



CERNIERE ANUBA REVERSIBILI TRIPLO GAMBO



TONDA ECRÙ

- A** Scorrevole a scomparsa
- C** ECRÙ
- T** KSV/V7
- M** Kit L/O Tonda
- P** Venatura orizzontale



Blindato SICURA

- C** ECRÙ
- T** Silver

DIMENSIONI TELAI

100 mm

TELAIO MDF CARB, FSC®

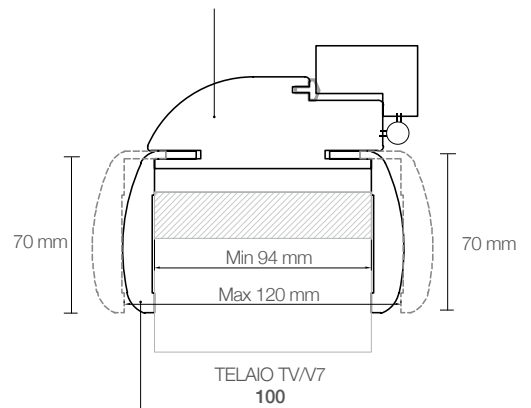

COPRIFILI MDF CARB, FSC®

ALLARGAMENTI MURO

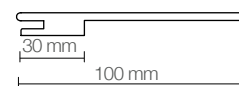

DIMENSIONI DISPONIBILI in mm	L	H	T
BATTENTE REVERSIBILE	600/700/800/900	2100	100
SCORREVOLE A SCOMPARSA	700/800	2100	105-125
PIEGO REVERSIBILE	700/800	2100	100
BLINDATO	800/900 sx e dx	2100	-

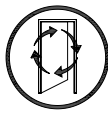

BATTENTE REVERSIBILE
ribaltando l'anta

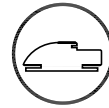

TELAIO TV/V7
100 MM

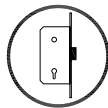

SERRATURA MEDIANA

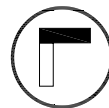

TELAIO 90°



BATTISCOPIA
NON DISPONIBILE

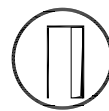

SCORREVOLE
A SCOMPARSA

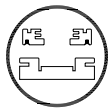

KSV/V7 per CASSONETTO
da 105 vuoto 72 → 125 vuoto 90

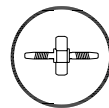

CERNIERE ANUBA
REVERSIBILI



GUARNIZIONE ACUSTICA

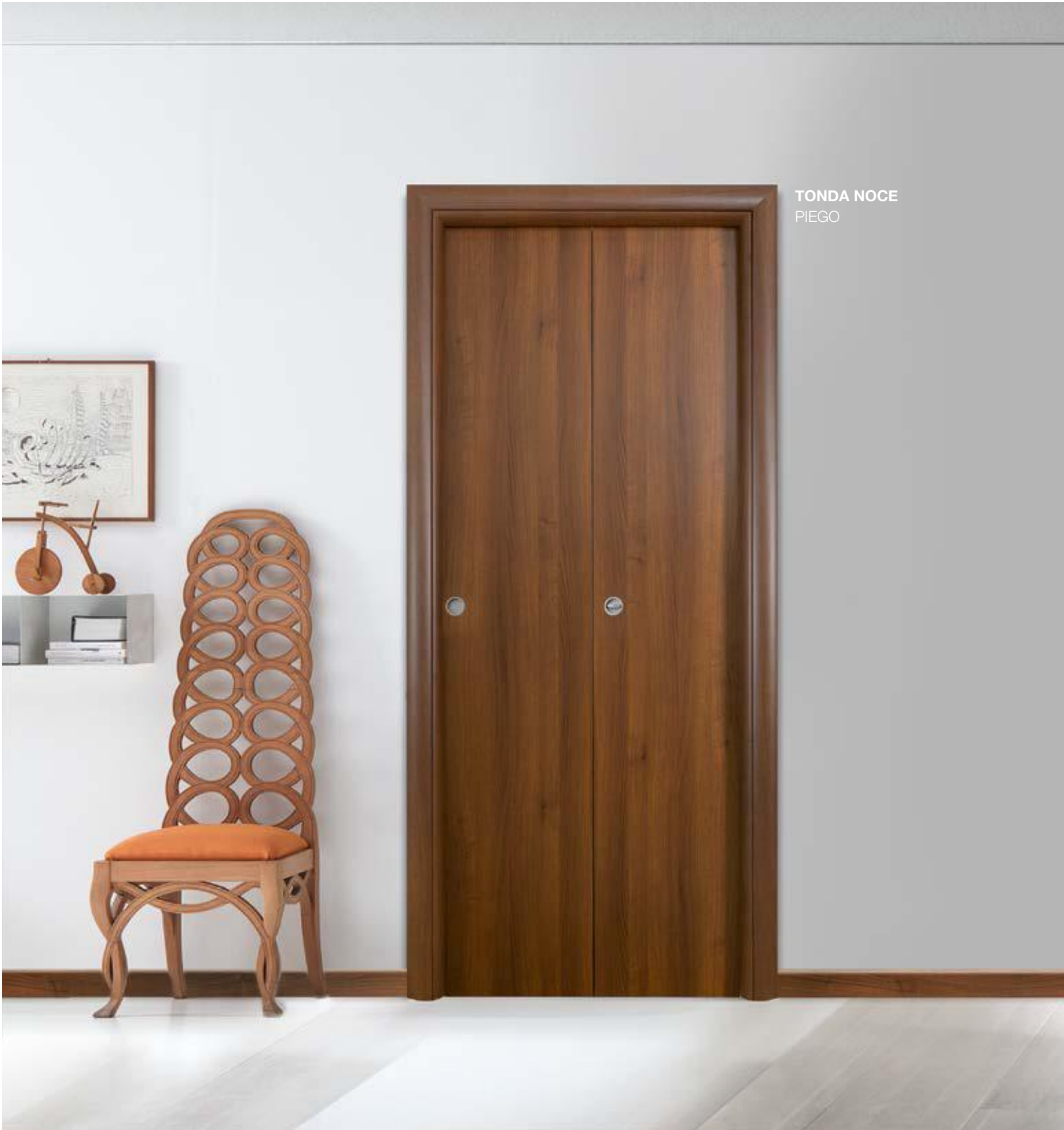

TONDA NOCE
PIEGO

TONDA NOCE
BATTENTE



TONDA NOCE



TONDA NOCE

- A** Battente reversibile
- C** NOCE NAZIONALE
- T** TV/V7
- M** Torsion cromo sat.
- P** Venatura verticale



TONDA NOCE

- A** Piego reversibile
- C** NOCE NAZIONALE
- T** TV/V7
- M** Kit L/O Tonda
- P** Venatura verticale



CERNIERE ANUBA REVERSIBILI TRIPLO GAMBO



TONDA NOCE

- A** Scorrevole a scomparsa
- C** NOCE NAZIONALE
- T** KSV/V7
- M** Kit L/O Tonda
- P** Venatura verticale



Blindato SICURA

- C** NOCE NAZIONALE
- T** Black

DIMENSIONI TELAI

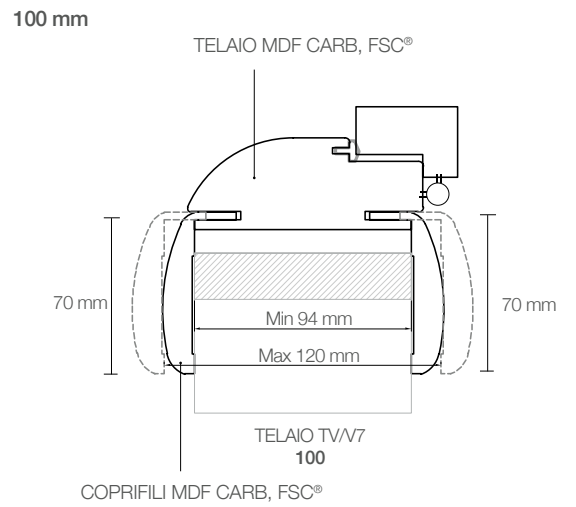

ALLARGAMENTI MURO



DIMENSIONI DISPONIBILI in mm	L	H	T
BATTENTE REVERSIBILE	600/700/800/900	2100	100
SCORREVOLE A SCOMPARSA	700/800	2100	105-125
PIEGO REVERSIBILE	700/800	2100	100
BLINDATO	800/900 sx e dx	2100	-



BATTENTE REVERSIBILE
ribaltando l'anta

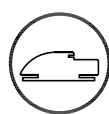

TELAIO TV/V7
100 MM

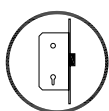

SERRATURA MEDIANA



TELAIO 90°

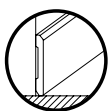

BATTISCOPI
IN ABBINAMENTO

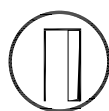

SCORREVOLE
A SCOMPARSA

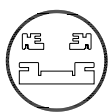

KSV/V7 per CASSONETTO
da 105 vuoto 72 → 125 vuoto 90

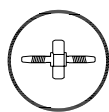

CERNIERE ANUBA
REVERSIBILI



GUARNIZIONE ACUSTICA

TONDA BIANCO
BATTENTE





SICURA SILVER
BIANCO MICRO

TONDA BIANCO



TONDA BIANCO

- A** Battente reversibile
- C** BIANCO MICRO
- T** TV/V7
- M** Linea cromo sat.
- P** Liscio



TONDA BIANCO

- A** Piego reversibile
- C** BIANCO MICRO
- T** TV/V7
- M** Kit L/O Tonda
- P** Liscio



CERNIERE ANUBA REVERSIBILI TRIPLO GAMBO



TONDA BIANCO

- A** Scorrevole a scomparsa
- C** BIANCO MICRO
- T** KSV/V7
- M** Kit L/O Tonda
- P** Liscio



TONDA BIANCO

- A** Scorrevole esterno muro
- C** BIANCO MICRO
- T** Binario esterno muro
- M** Kit unghiata Tonda
- P** Liscio



Blindato SICURA

- C** BIANCO MICRO
- T** White

DIMENSIONI TELAI

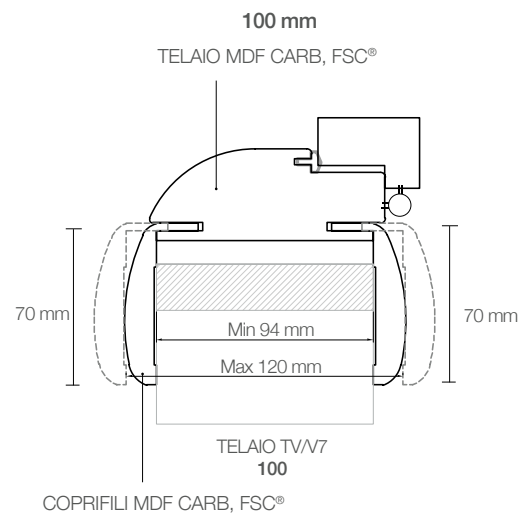

ALLARGAMENTI MURO

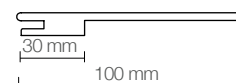

DIMENSIONI DISPONIBILI in mm	L	H	T
BATTENTE REVERSIBILE	600/700/800/900	2100	100
SCORREVOLE A SCOMPARSA	700/800	2100	105-125
SCORREVOLE ESTERNO MURO	700/800	2100	-
PIEGO REVERSIBILE	700/800	2100	100
BLINDATO	800/900 sx e dx	2100	-

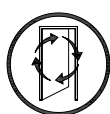

BATTENTE REVERSIBILE
ribaltando l'anta

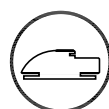

TELAIO TV/V7
100 MM

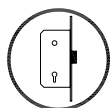

SERRATURA
MEDIANA

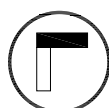

TELAIO 90°

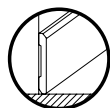

BATTISCOPA
IN ABBINAMENTO

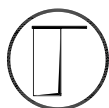

SCORREVOLE
ESTERNO MURO

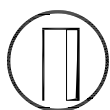

SCORREVOLE
A SCOMPARSA

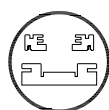

KSV/V7 per CASSONETTO
da 105 vuoto 72 → 125 vuoto 90

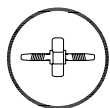

CERNIERE ANUBA
REVERSIBILI



GUARNIZIONE ACUSTICA

Aperture e finiture disponibili



FILOMURO PRIMER **REVERSIBILE**
N° 2 CERNIERE

- A** Battente reversibile
- C** PRIMER VERNICIABILE
- T** TELAIO REVERSIBILE
- M** Maniglia Biblo



FILOMURO PRIMER **SCORREVOLE**
UNIVERSAL

- A** Scorrevole a scomparsa
- C** PRIMER VERNICIABILE
- T** CASSONETTO FILOMURO
- M** Kit L/O Kuader



FILOMURO PRIMER **NON REVERSIBILE**
N° 3 CERNIERE

- A** Battente DX o SX
- C** PRIMER VERNICIABILE
- T** TELAIO DX o SX
- M** Maniglia Biblo

Dimensioni disponibili

***BATTENTE - PRIMER REVERSIBILE**

600/700/800/900 x 2100 mm

SCORREVOLE A SCOMPARSA FILOMURO UNIVERSAL PRIMER

700/800/900 x 2100 mm

BATTENTE - NON REVERSIBILE PRIMER DX E SX

600/700/800/900 x 2100 mm

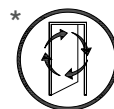

BATTENTE REVERSIBILE
ribaltando l'anta

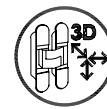

CERNIERE A SCOMPARSA



SERRATURA MAGNETICA



GUARNIZIONE ACUSTICA

Anta con fresatura superiore per accogliere le staffe (fornite dai produttori di cassonetti a filomuro) delle principali marche: Scigno essential / Eclisse sythesis line / Dierre New Space rasomuro/ Protek linear Ermetika absolute evo.

Tipologie di installazione possibili con **UN UNICO TELAIO**

SIA REVERSIBILE, SIA DX O SX

CARTONGESSO

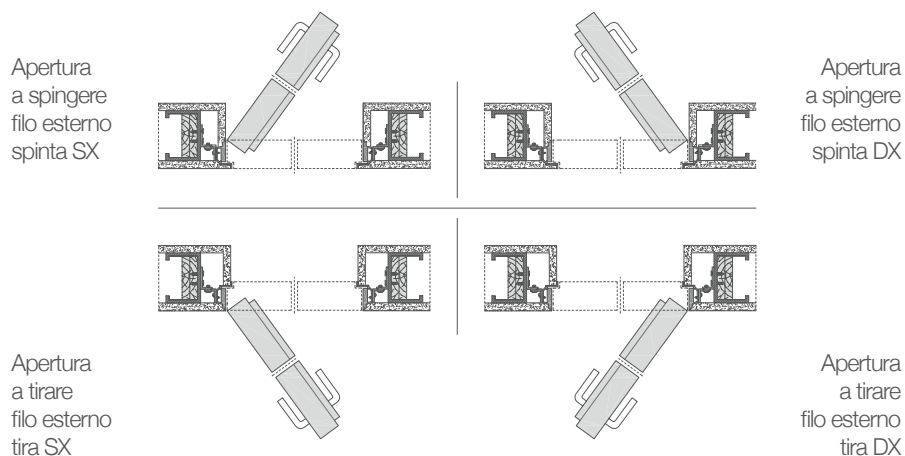

MURATURA

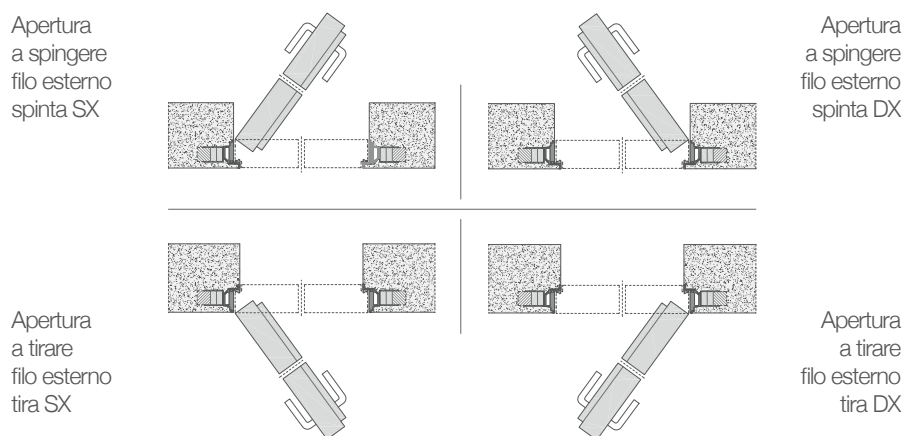

Con i telai vengono fornite nel kit, le zanche per muratura e staffe per cartongesso e rete in fibra di vetro per le stuccature o intonaco.

Per la versione reversibile primer, un unico telaio e un'unica anta, da ruotare in fase di posa.

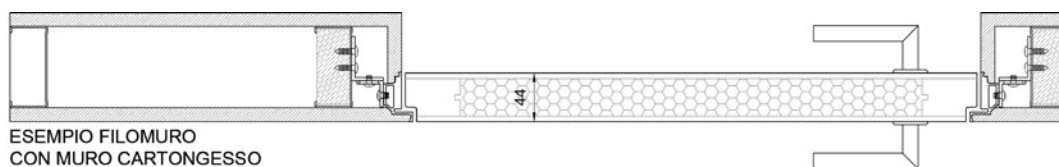

MDF 4MM
PRIMER VERNICIABILE
IDRO CARB FSC

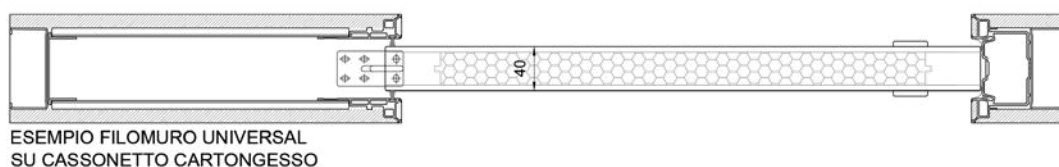



PORTA SICURA BLACK
RIVESTIMENTO ESTERNO
CREMONESE TORTORA PVC



PORTA SICURA BLACK
RIVESTIMENTO INTERNO
RISO



PORTA SICURA BLACK
RIVESTIMENTO ESTERNO
TORINESE BIANCO PVC



PORTA SICURA BLACK
RIVESTIMENTO ESTERNO
MILANESE NOCE PVC

DOTAZIONI DI SERIE

Dimensioni disponibili

PORTA BLINDATA 800/900 x 2100 mm spinta SX e DX con falso telaio



Protezione antintrusione
CLASSE 3 secondo norma
Europea ENV 1627-1



N° 7 punti
di chiusura mobili



N° 5 chiavi con
profilo speciale
lato esterno + 1 da cantiere



Trasmittanza
termica U=1,2



4 rostri di sicurezza
posti sul lato cerniera



Defender
anti tubo certificato
Tonda argento



Abbattimento acustico 36dB



Limitatore di apertura
Block a traslazione
(catenella) Tonda argento



Soglia mobile
automatica inferiore



Istituto certificatore
e collaudatore
"Istituto Giordano"



Serratura movimento
a leve, a cilindro



Spioncino
grandangolare argento



Sigillo in battuta
marchio Albert



Cilindro europeo
chiave esterna
pomolino interno
Tonda argento

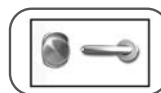

Kit maniglia Tonda argento
pomolo esterno
fisso/girevole + maniglia interna

CERNIERA REGOLABILE

CAPPUCCI COPRICERNIERA

COIBENTAZIONE
LANA DI ROCCIA

COIBENTAZIONE EPS

PANNELLO
RIVESTIMENTO INTERNO

ROSTRI FISSI GIREVOLI
ANTI TAGLIO

CARENE SMONTABILI
PER SOSTITUZIONE
RIVESTIMENTO A PORTA
MONTATA SFILANDOLO
LATERALMENTE

LIMITATORE APERTURA
BLOCK CATENELLA
A TRASLAZIONE



SERRATURA YALE
AD ALTA SICUREZZA

PIASTRE AL MANGANESE
A PROTEZIONE
DELLA SERRATURA

LATO
INTERNO



SICURA BLACK

LATO
ESTERNO



SICURA BLACK

SICURA BLACK

- Telaio e carena **Nero**
- Rivestimento **interno Bianco Micro**
- Rivestimento **esterno Noce Nazionale**
- Cilindro con chiave esterna e pomolino interno
- Maniglia **esterna Tonda Argento**: pomolo fisso o girevole*
- Maniglia **interna Tonda Argento**: maniglia + pomolino
- Spioncino **argento**
- Pomolino catenella **Tonda Argento**
- Guarnizione di battuta nera
- **Limitatore** apertura block/catenella
- Cappucci copricerniera **neri**
- Trasmittanza termica **1,2 W/m²k**
- Per altri rivestimenti vedere pag. 4/5



SICURA SILVER



SICURA SILVER

SICURA SILVER

- Telaio e carena **Silver**
- Rivestimento **interno Bianco Micro**
- Rivestimento **esterno Noce Nazionale**
- Cilindro con chiave esterna e pomolino interno
- Maniglia **esterna Tonda Argento**: pomolo fisso o girevole*
- Maniglia **interna Tonda Argento**: maniglia + pomolino
- Spioncino **argento**
- Pomolino catenella **Tonda Argento**
- Guarnizione di battuta grigia
- **Kit guarnizione** a C nera, per rendere lo stipite **bicolore** (Silver interno/Nero esterno)
- **Limitatore** apertura block/catenella
- Cappucci copricerniera **argento**
- Trasmittanza termica **1,2 W/m²k**
- Per altri rivestimenti vedere pag. 4/5



SICURA WHITE



SICURA WHITE

SICURA WHITE

- Telaio e carena **Bianco**
- Rivestimento **interno Bianco Micro**
- Rivestimento **esterno Noce Nazionale**
- Cilindro con chiave esterna e pomolino interno
- Maniglia **esterna Tonda Argento**: pomolo fisso o girevole*
- Maniglia **interna Tonda Argento**: maniglia + pomolino
- Spioncino **argento**
- Pomolino catenella **Tonda Argento**
- Guarnizione di battuta grigia
- **Kit guarnizione** a C nera, per rendere lo stipite **bicolore** (Bianco interno/Nero esterno)
- **Limitatore** apertura block/catenella
- Cappucci copricerniera **bianchi**
- Trasmittanza termica **1,2 W/m²k**
- Per altri rivestimenti vedere pag. 4/5

SICURA BLACK - SILVER - WHITE

Finiture carene e telai Sicura



CARENE E TELAIO BLACK

Guarnizione di battuta nera

SICURA BLACK



CARENE E TELAIO SILVER

Guarnizione di battuta grigia - in dotazione
guarnizione a C nera, per rendere lo stipite bicolore
Silver interno / Nero esterno

SICURA SILVER



CARENE E TELAIO WHITE

Guarnizione di battuta grigia - in dotazione
guarnizione a C nera, per rendere lo stipite bicolore
Bianco interno / Nero esterno

SICURA WHITE

Sicura monta rivestimenti nella carenatura a graffa (senza angolari) di spessore 6 mm.
Telaio e carenatura sono Black / Silver / White

GUARNIZIONE DI BATTUTA

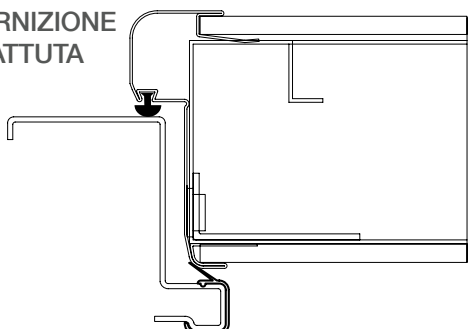

GUARNIZIONE A C

La guarnizione a C nera ad incastro permette di rendere lo stipite bicolore

Maniglie disponibili

TONDA ARGENTO di serie, **QUADRA ARGENTO**, **TONDA ORO LUCIDO** E **TONDA BRONZO** a richiesta.
MANIGLIONE ARGENTO a richiesta, fornito in aggiunta al pomolo.

KIT MANIGLIERIA TONDA ARGENTO



ESTERNO INTERNO
 No spioncino (Già nella porta)

KIT MANIGLIERIA TONDA ORO LUCIDO



ESTERNO INTERNO
 Spioncino oro lucido

KIT MANIGLIERIA TONDA BRONZO



ESTERNO INTERNO
 Spioncino bronzo

KIT MANIGLIERIA QUADRA ARGENTO

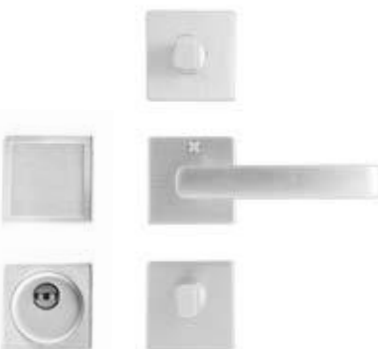

ESTERNO INTERNO
 No spioncino (Già nella porta)

MANIGLIONE ARGENTO

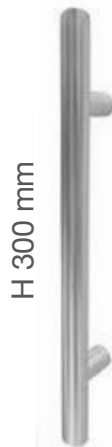

SOLO LATO ESTERNO

Per il maniglione montato da solo senza pomolo (di serie) occorre ordinare un nuovo pannello (vedi p.108) senza fori.

MANIGLIERIA IN DOTAZIONE: TONDA DI SERIE E QUADRA A RICHIESTA



Rivestimenti lisci a richiesta per ambienti interni

MDF, CARB, FSC®

I rivestimenti interni a richiesta vengono forniti imballati **sfusi, di serie non forati**.

A richiesta, con maggiorazione di prezzo, possono essere forniti **già montati** sul blindato Sicura:

+ 7 giorni di approntamento.

Misura standard pannelli lisci **2125x970 mm, spessore 6 mm**. (Montano su varie marche di porte blindate)

I pannelli **Mogano, Bianco Micro e Tanganica** non seguono le dimensioni sopra riportate, ma misurano **2098x907 mm** (porta Sicura 2100x900 mm), **spessore 6 mm**.

**N.B. SICURA MONTA LA STESSA MISURA
DI PANNELLO ALL'INTERNO O ALL'ESTERNO**

RIVESTIMENTI SFUSI = NON FORATI

RIVESTIMENTI MONTATI = FORATI



BIANCO LACCATO

BIANCO STRUTTURA

CALCE

BIANCO MATRIX

AVENA MATRIX



RISO

ORZO

FARRO

BIANCO HD

NOCE NAZIONALE



ECRÙ

BIANCO MICRO

CORDA

LATTE

MOGANO

TANGANICA

Rivestimenti pantografati a richiesta per ambienti esterni

MDF, CARB, FSC®, IDRO, PVC/OKOUMÈ

I rivestimenti a richiesta per esterni vengono forniti imballati **sfusi, di serie non forati**.

A richiesta, con maggiorazione di prezzo, possono essere forniti **già montati** sul blindato: **+ 7 giorni** di approntamento.

Misure standard: **2098x807 mm** (porta Sicura 2100x800 mm) e **2098x907 mm** (porta Sicura 2100x900 mm), **spessore 7 mm**.

N.B. SICURA MONTA LA STESSA MISURA
DI PANNELLO ALL'INTERNO O ALL'ESTERNO

RIVESTIMENTI SFUSI = NON FORATI

RIVESTIMENTI MONTATI = FORATI

PVC = MDF IDRO 7 mm

OKOUMÈ = COMPENSATO MARINO 7 mm

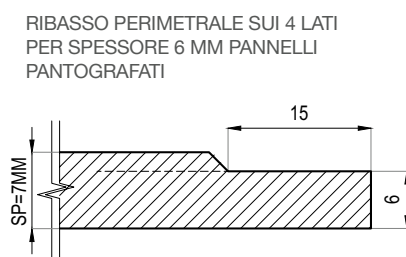
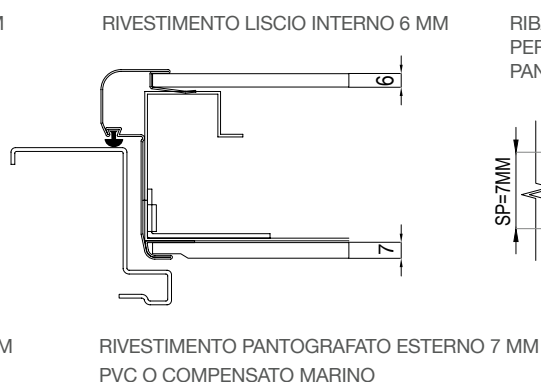
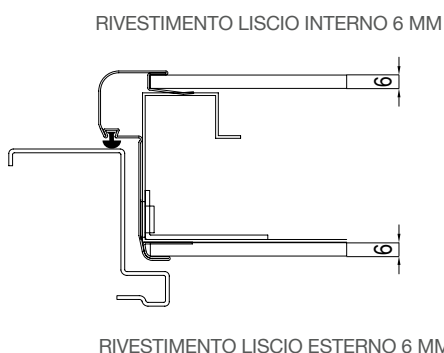

SICURA RIVESTIMENTI

Spioncino digitale

Accessorio per qualsiasi porta blindata
Vedi l'immagine in diretta di chi è alla tua porta
Visualizza un'immagine chiara anche a distanza
Schermo LCD 3.2"
Fotocamera 0.3 MP con angolo di visione a 105 gradi
Installazione molto semplice
Spessore della porta da 38 a 110 mm
Include 2 batterie AAA
Finitura argento



INTERNO



ESTERNO

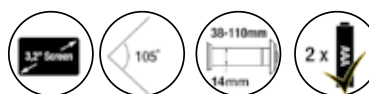
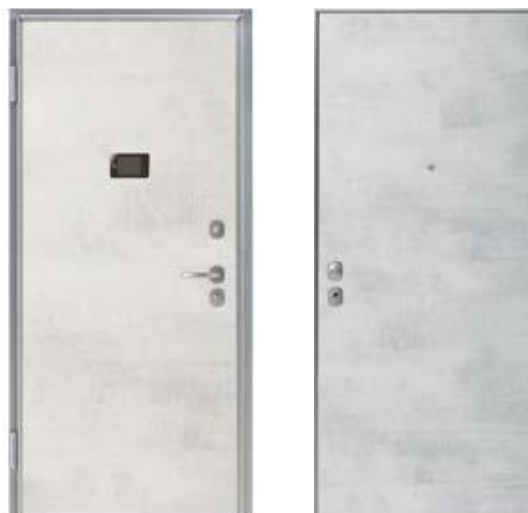

Angolari

Angolari forniti sfusi in kit da 3 aste.
Universali per varie tipologie di blindato.

Finiture disponibili:

- Bianco Laccato
- Bianco Matrix
- Avena Matrix
- Bianco Struttura
- Bianco Hd
- Bianco Micro

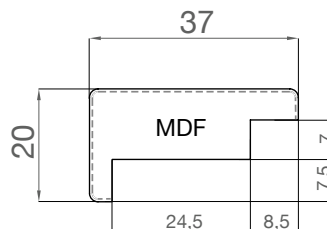

DETTAGLIO TECNICO

Le porte blindate Sicura non necessitano degli angolari.



Falso telaio

FALSO TELAIO ASSEMBLATO



KIT FALSO TELAIO SMONTATO



DETTAGLIO CAVALLOTTI SISTEMA BREVETTATO

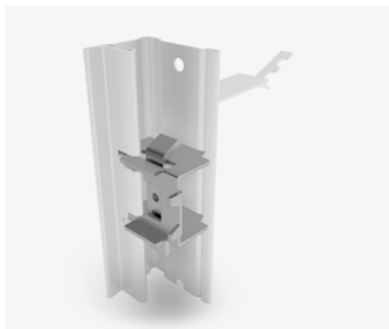

Sistema di fissaggio stipite e falso telaio con regolazione



Falso telaio brevettato con sistema di assemblaggio ad incastro



Il sistema di fissaggio permette allo stipite di diventare un corpo unico con la muratura

Sistema scorrevole esterno muro



UNGHIATE



KIT UNGHIATA TONDA
cromo satinato
DI SERIE

KIT UNGHIATA TONDA
oro lucido
A RICHIESTA

KIT UNGHIATA KUADER
cromo satinato
A RICHIESTA

Profili allargatori anta

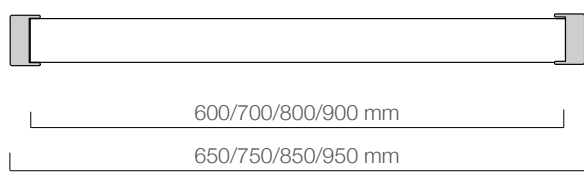

Sistema guida

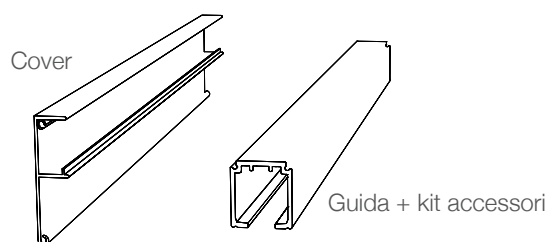

I n° 2 profili allargatori con adesivo già predisposto, sono da installare sui lati verticali dell'anta, consentendo di ottenere la larghezza desiderata maggiorata di 50 mm, al fine di coprire i vani muro finiti, intonacati, standard.

L' anta da 700 mm diventa 750 mm, l'anta da 800 mm diventa da 850 mm.

Non è possibile installare incontri di battuta e serrature di chiusura sul sistema scorrevole esterno muro.

Il sistema scorrevole esterno muro si può avere soltanto nei modelli indicati a catalogo:

Tonda Bianco/Bianco HD/Bianco HD Vetro/Bianco Struttura/Bianco Matrix/Cieca Liscia/Dynamic/Style/Classic/Trendy.

SERRATURA
SCORREVOLE A SCOMPARSA



SERRATURA SCORREVOLE
SCOMPARSA L/O
CON APPIGLIO **DI SERIE**



SERRATURA SCORREVOLE
SCOMPARSA L/O
CON APPIGLIO oro lucido
A RICHIESTA



KIT L/O TONDA
cromo satinato
DI SERIE



KIT L/O TONDA
oro lucido
A RICHIESTA

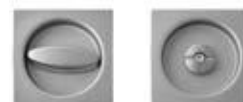

KIT L/O KUADER
cromo satinato
A RICHIESTA

SERRATURA BATTENTE



SERRATURA MEDIANA MECCANICA DI SERIE



CERNIERE ANUBA REVERSIBILI MONO GAMBO



CERNIERE ANUBA REVERSIBILI TRIPLO GAMBO



SERRATURA MAGNETICA DI SERIE



CERNIERE INVISIBILI AIR 120° DI SERIE



CERNIERA AIR 180° REVERSIBILE A RICHIESTA CONSENTE L'APERTURA DELL'ANTA DI 180°



MAGNETICA YALE CON CILINDRO A RICHIESTA



MAGNETICA CON LIBERO OCCUPATO A RICHIESTA



MAGNETICA CON CHIAVE oro lucido A RICHIESTA



MAGNETICA CON LIBERO OCCUPATO oro lucido A RICHIESTA



SERRATURA MAGNETICA DI SERIE



CERNIERE A SCOMPARSA DI SERIE SU PORTE FILOMURO

Maniglie porte interne



BIBLO CROMO LUCIDO



BIBLO CROMO SATINATO



LIME CROMO LUCIDO



LIME CROMO SATINATO



DOE CROMO LUCIDO



DOE CROMO SATINATO



TORSION CROMO SATINATO



GOCCIA CROMO SATINATO



TOWN CROMO SATINATO



VIRGOLA CROMO SATINATO



LINEA CROMO SATINATO



VIRGOLA ORO LUCIDO



LINEA ORO LUCIDO

N.B. La porta ha foro per serratura chiave e L/O. In caso di serratura Yale il cliente dovrà allargare in autonomia il foro chiave per accogliere il cilindro Yale.

Allargamenti disponibili



ALLARGAMENTI DISPONIBILI

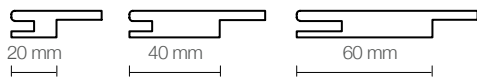

20/40/60 mm= Kit da 3 aste

CIECA LISCIA/DYNAMIC/CROSS/CLASSIC/STYLE/TRENDY/CALCE/BIANCO STRUTTURA/BIANCO HD/ BIANCO HD VETRO

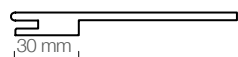

100 mm= Kit da 5 aste

CIECA LISCIA/DYNAMIC/CROSS/CLASSIC/STYLE/TRENDY

BIANCO HD/BIANCO HD VETRO

MATRIX AVENA/MATRIX AVENA VETRO/TONDA BIANCO/NOCE NAZIONALE

NOCE NAZIONALE VETRO/TONDA NOCE/LATTE

CORDA/QUADRA BIANCO/BAND/TONDA ECRÙ/MATRIX BIANCO

MATRIX BIANCO VETRO

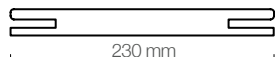

230 mm= Kit da 1 asta

CIECA LISCIA/DYNAMIC/CROSS/CLASSIC/STYLE/TRENDY/BIANCO STRUTTURA/CALCE

BIANCO HD/BIANCO HD VETRO/RISO/ORZO/FARRO

NOCE NAZIONALE/NOCE NAZIONALE VETRO

COPRIFILO BIG

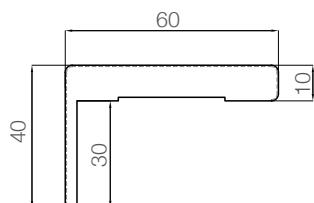

BIANCO LACCATO
BIANCO MICRO
ECRU
NOCE



Battiscopa

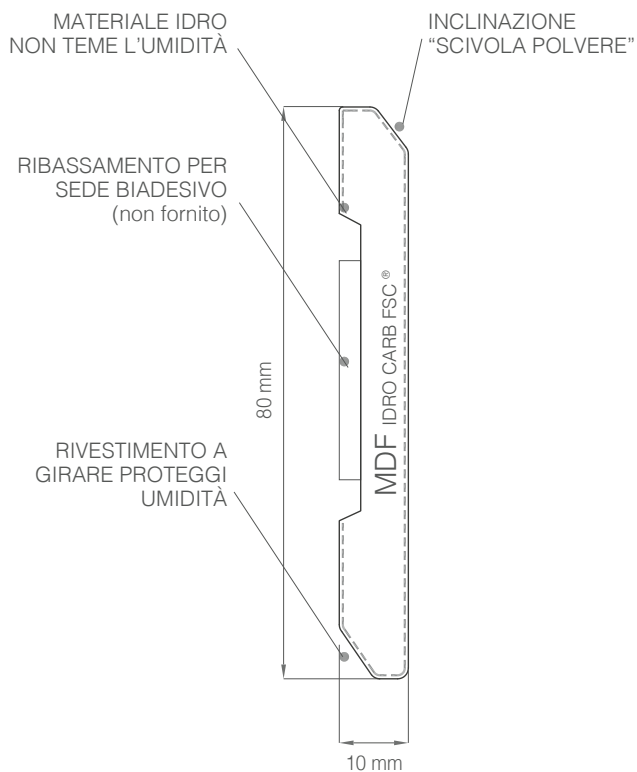

COLORI BATTISCOPIA B8 80X10 mm IDRO	
BIANCO LACCATO BIANCO HD - HD VETRO TONDA BIANCO QUADRA BIANCO - BAND	√ BIANCO
RISO	√
ORZO	√
FARRO	√
NOCE NAZIONALE - NOCE VETRO TONDA NOCE	√ NOCE
BIANCO STRUTTURA BIANCO MATRIX	√ BIANCO MATRIX
AVENA MATRIX	√
CALCE	√
LATTE	√

Il kit battiscopa è composto da 5 aste, ognuna di lunghezza 225 cm per un totale di 11,25 mt. Non sono acquistabili aste sfuse.



ALLARGAMENTI - BATTISCOPIA

Telai porte interne

CIECA LISCIA - DYNAMIC - CROSS - CLASSIC - STYLE - TRENDY - CALCE - BIANCO STRUTTURA

TLS/L8

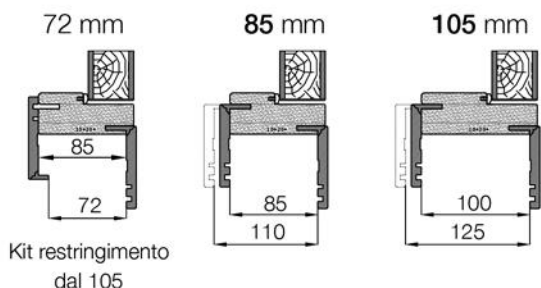

KLS/L8 da 105 estende a 125

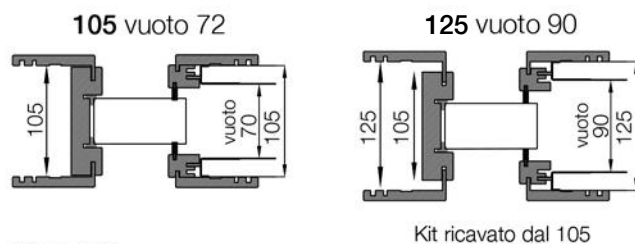

KLS/L8

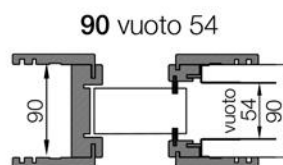

BIANCO MATRIX - BIANCO MATRIX VETRO - AVENA MATRIX - AVENA MATRIX VETRO

TLS-A/L8

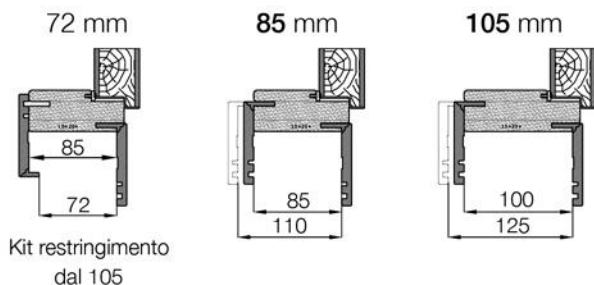

KLS/L8 da 105 estende a 125

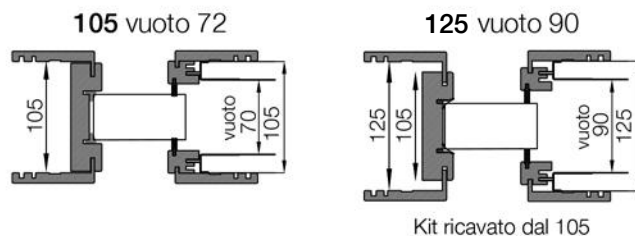

BIANCO HD - BIANCO HD VETRO - NOCE NAZIONALE - NOCE NAZIONALE VETRO - RISO - ORZO - FARRO

TK/L8

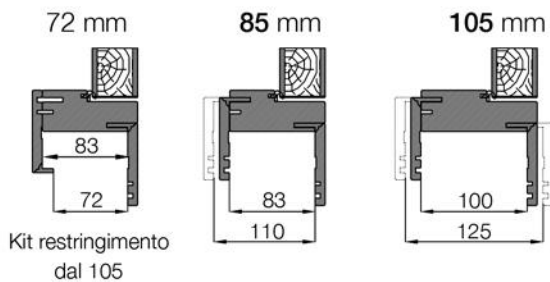

KSK/L8 da 105 estende a 125

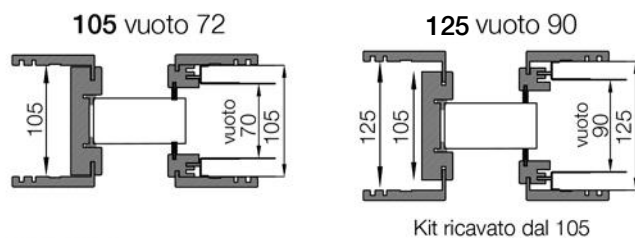

KSK/L8

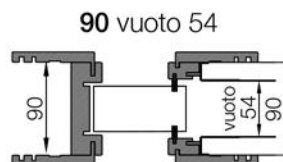

Telai porte interne

LATTE - CORDA - QUADRA BIANCO - BAND

TP/L6

72 mm

100 mm

100 > 125 mm

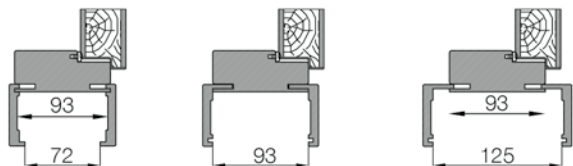

Kit restringimento
dal 105

KSV/L6 da 105 estende a 125

105 vuoto 72

125 vuoto 90

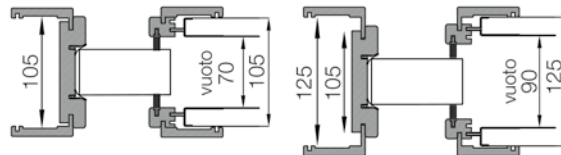

Kit ricavato dal 105

TONDA ECRÙ - TONDA NOCE - TONDA BIANCO

TV/V7

100 mm

100 > 120 mm

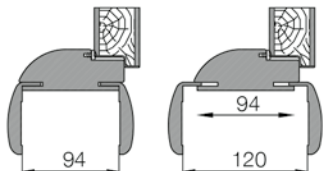

KSV/V7 da 105 estende a 125

105 vuoto 72

125 vuoto 90

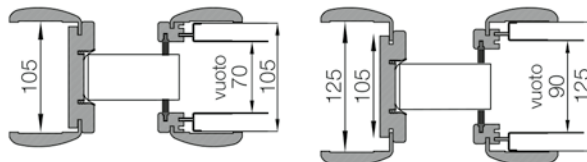

Kit ricavato dal 105

Dettaglio TK/L8

BIANCO HD / NOCE NAZIONALE / RISO / ORZO / FARRO

ESEMPIO LUCE 800X2100

PORTA BATTENTE REVERSIBILE TELAIO TK / L8

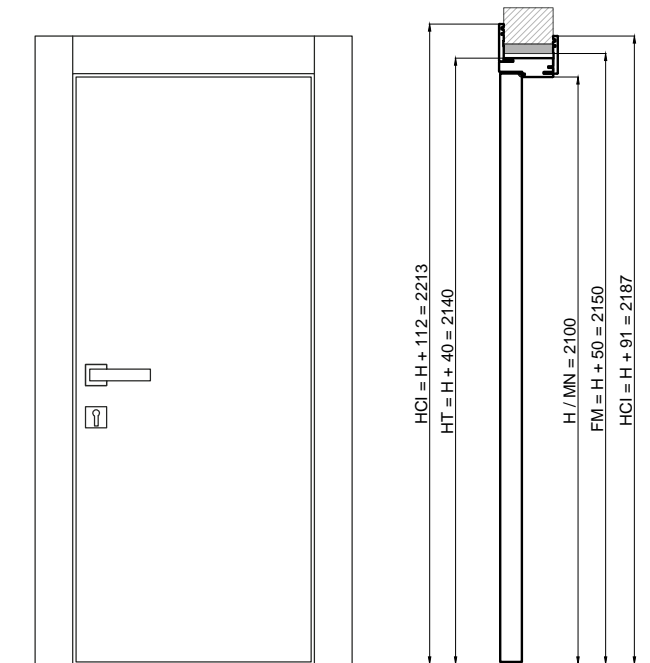

PORTA SCORREVOLE A SCOMPARSITA TELAIO KSK / L8

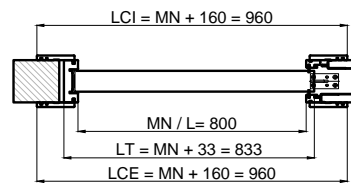
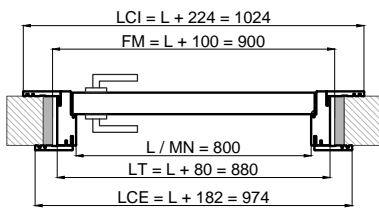
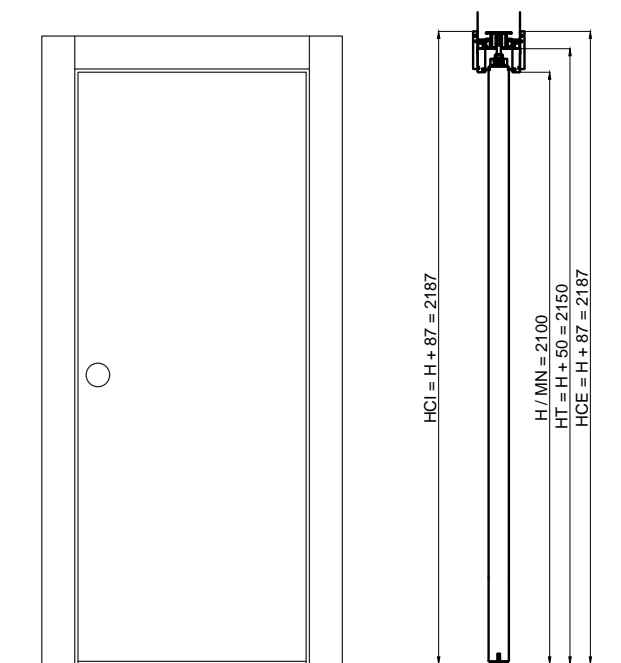

Dettaglio TLS-A/L8

BIANCO MATRIX / AVENA MATRIX

ESEMPIO LUCE 800X2100

PORTA BATTENTE REVERSIBILE TELAIO TLS-A / L8

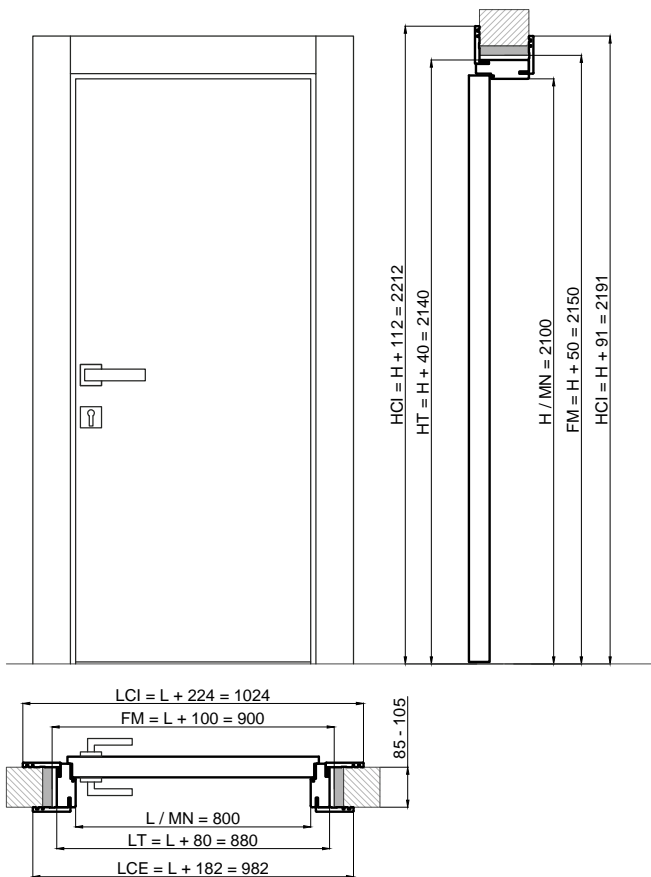

PORTA SCORREVOLE A SCOMPARSA TELAIO KLS / L8

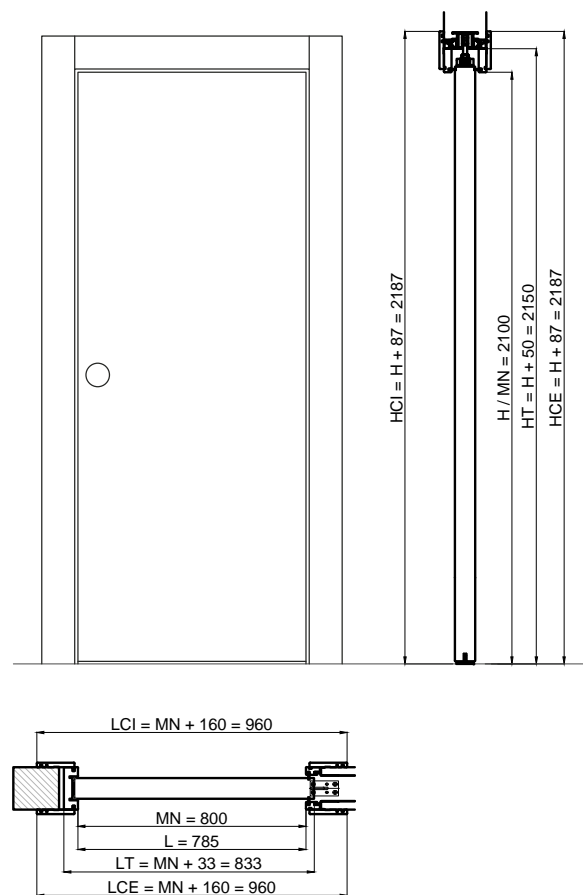

PORTA PIEGO REVERSIBILE TELAIO TLS-A / L8

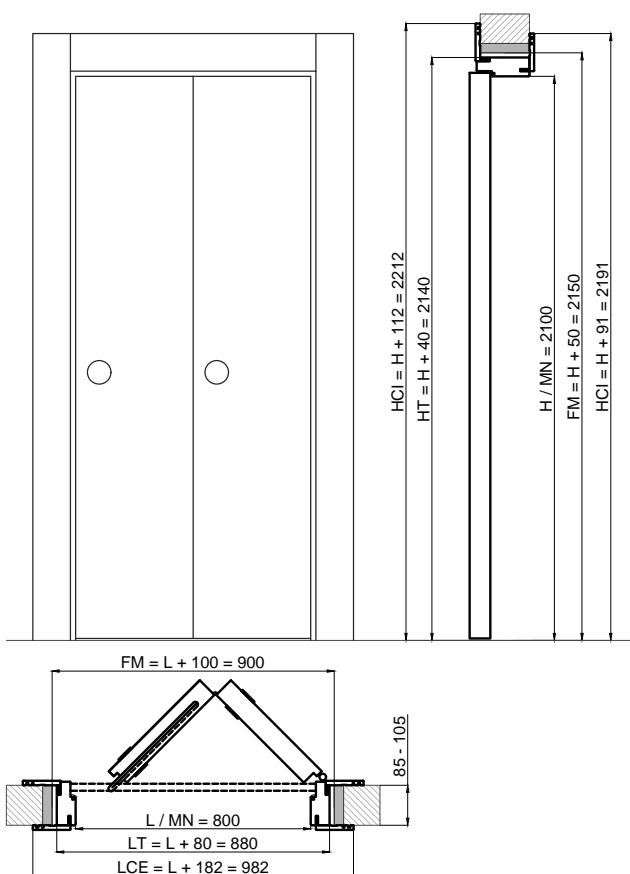

PORTA ROTOTRASLANTE TELAIO PKROTO / L8

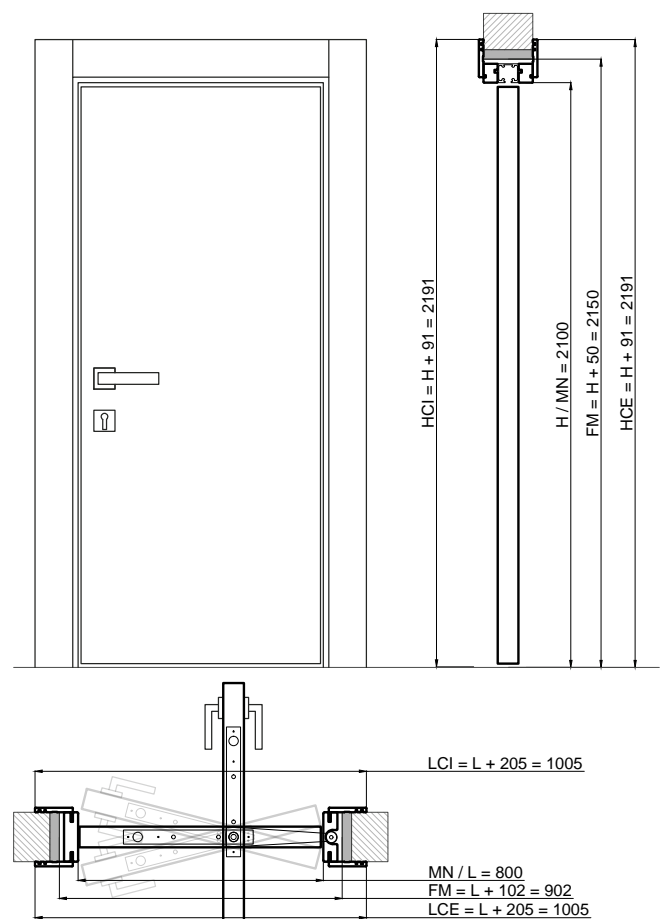

SCHEDE TECNICHE

Dettaglio TLS/L8

CIECA LISCIA / DYNAMIC / CROSS / CLASSIC / STYLE / TRENDY / CALCE / BIANCO STRUTTURA

ESEMPIO LUCE 800X2100

PORTA BATTENTE REVERSIBILE TELAIO TLS / L8

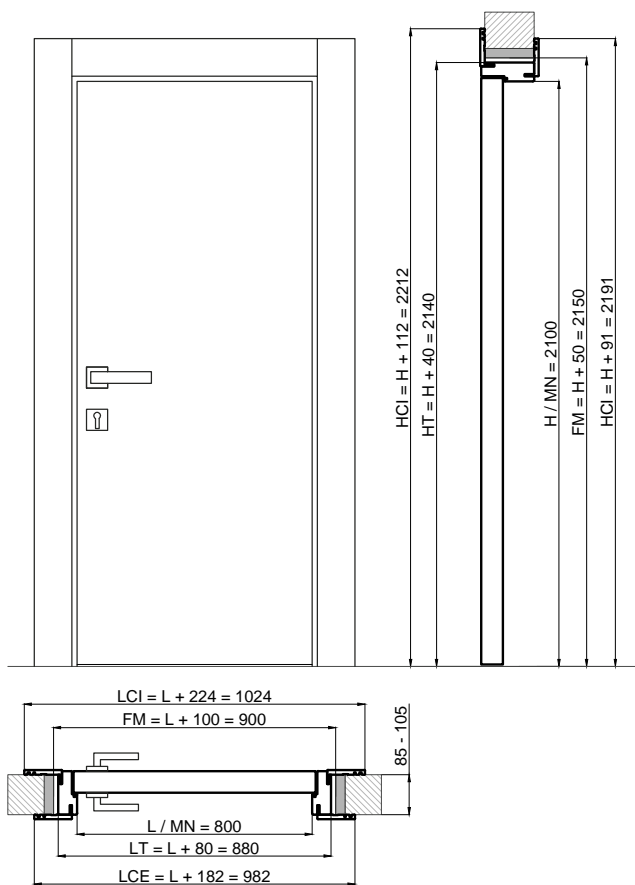

PORTA SCORREVOLE A SCOMPARSA TELAIO KLS / L8

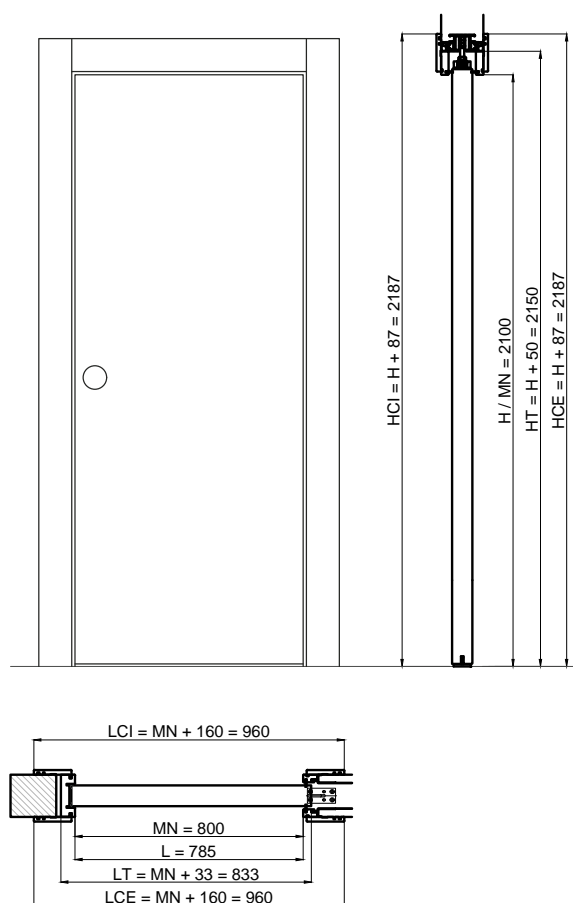

PORTA DOUBLE' REVERSIBILE TELAIO TLS / L8

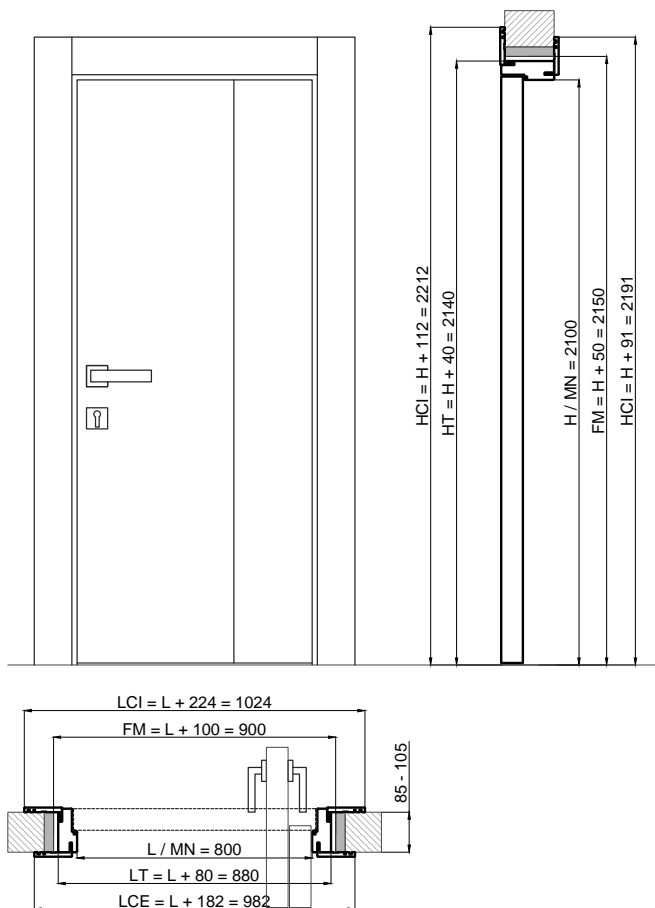

PORTA ROTOTRASLANTE REVERSIBILE TELAIO PKROTO / L8

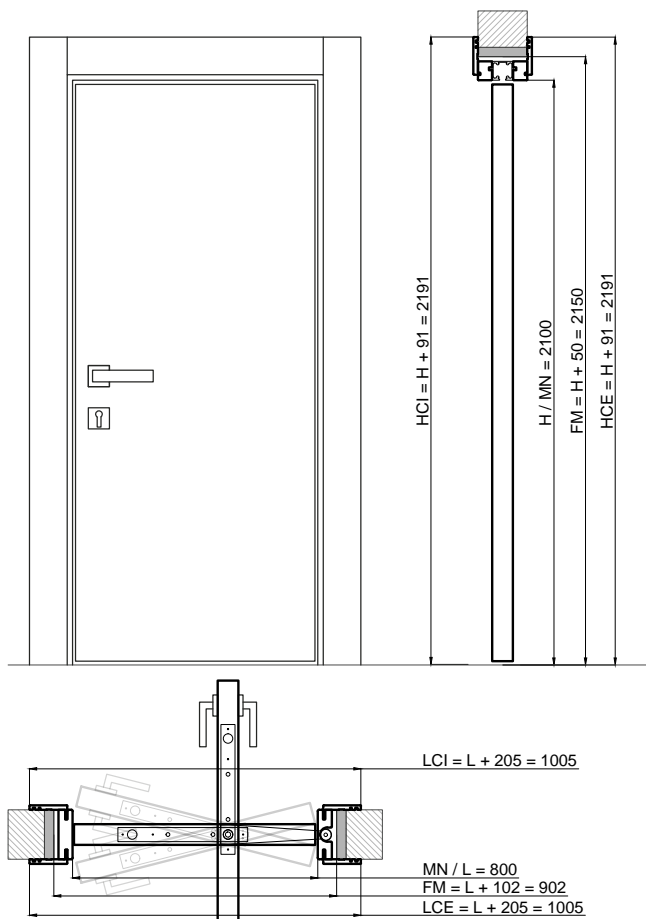

Dettaglio TP/L6

LATTE / CORDA / QUADRA BIANCO / BAND

ESEMPIO LUCE 800X2100

PORTA BATTENTE REVERSIBILE TELAIO TP / L6

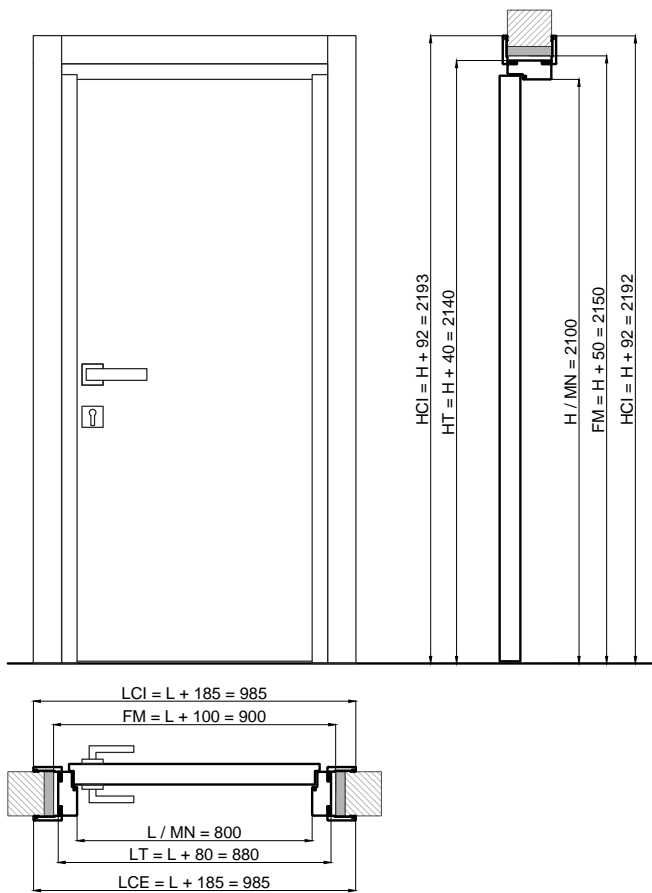

PORTA SCORREVOLE A SCOMPARSA TELAIO KSP / L6

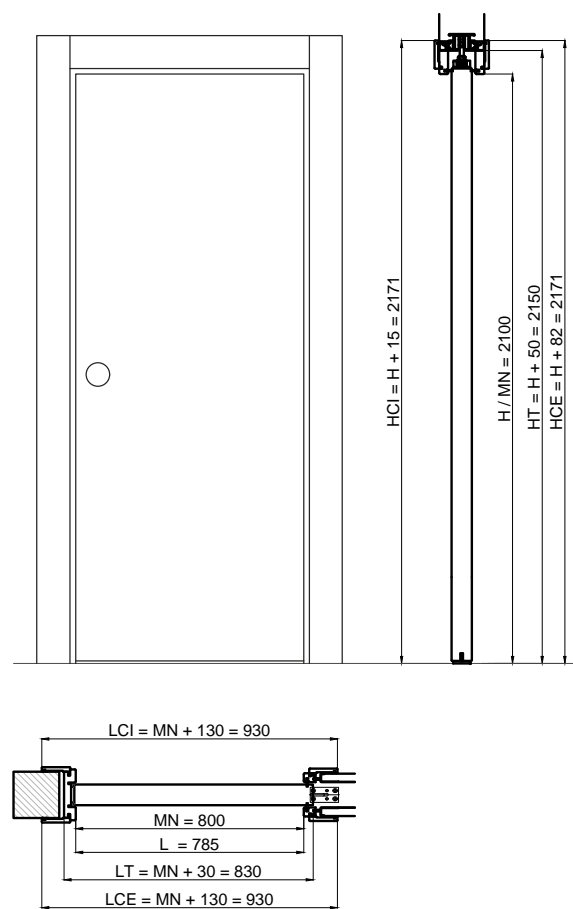

Dettaglio TV/V7

TONDA ECRÙ / TONDA NOCE / TONDA BIANCA

ESEMPIO LUCE 800X2100

PORTA BATTENTE REVERSIBILE TELAIO TV / V7

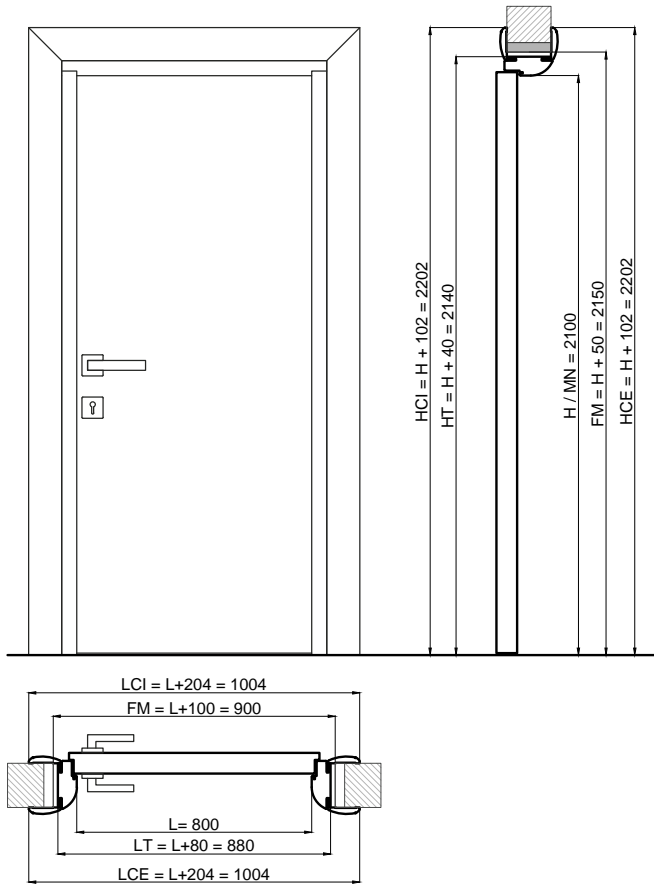

PORTA SCORREVOLE A SCOMPARSA TELAIO KSV / V7

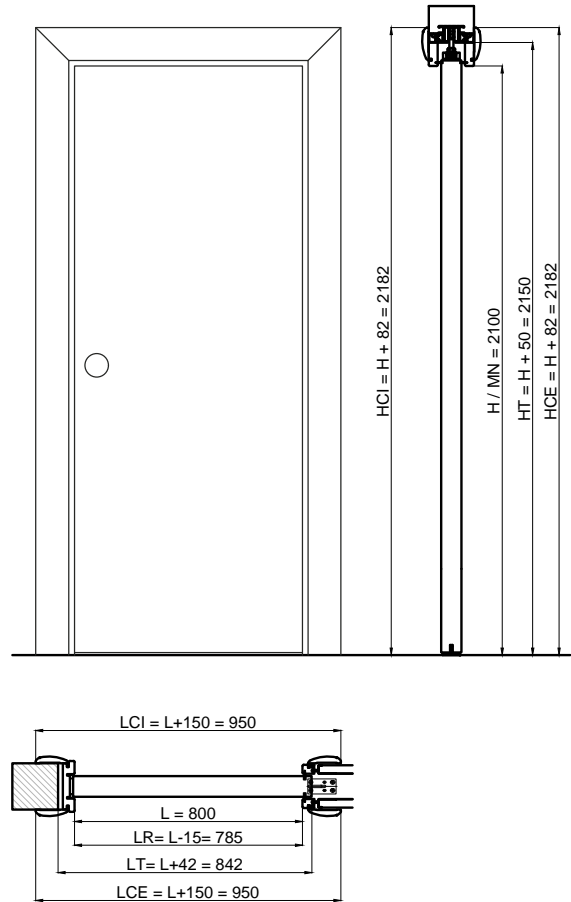

PORTA PIEGO REVERSIBILE TELAIO TV / V7

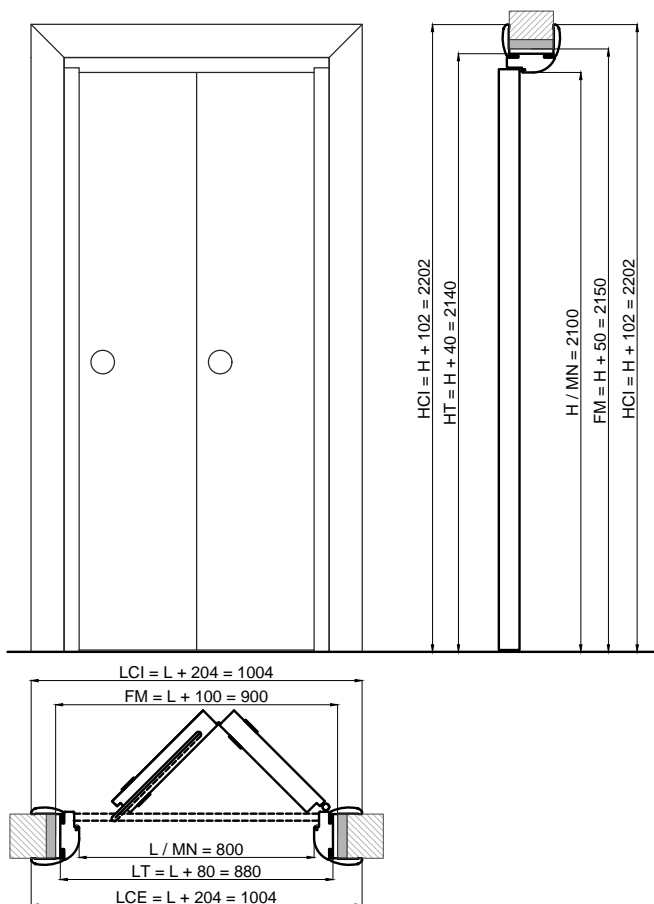

Dettaglio scorrevole esterno muro

CIECA LISCIA / DYNAMIC / CLASSIC / STYLE / TRENDY / BIANCO MATRIX / BIANCO STRUTTURA
BIANCO HD / BIANCO HD VETRO / TONDA BIANCO

ESEMPIO LUCE 800X2100
PORTA SCORREVOLE ESTERNO MURO

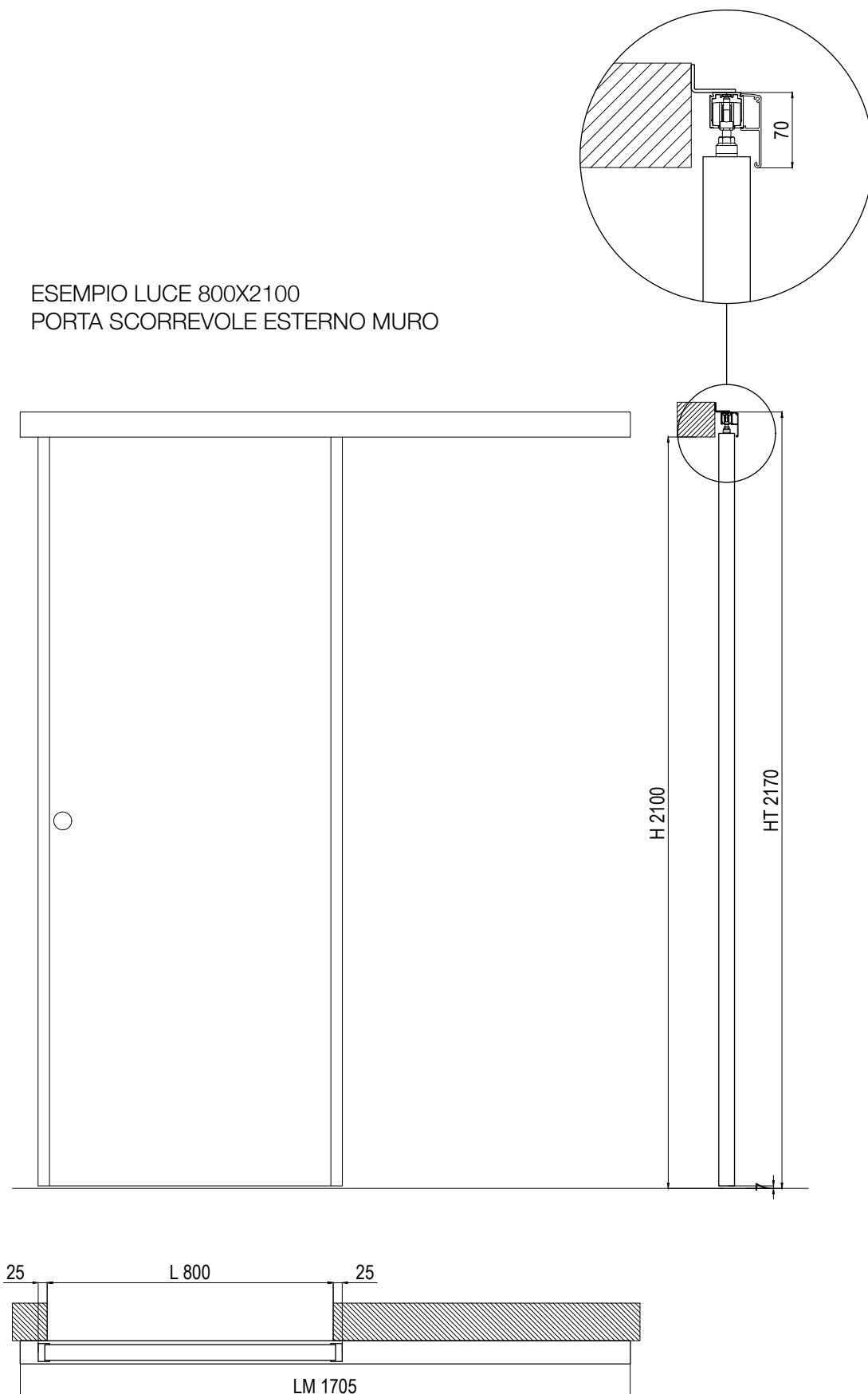

Dettaglio falsi telai e porta Sicura

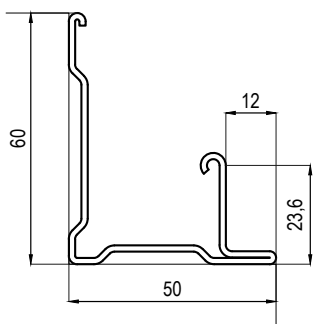
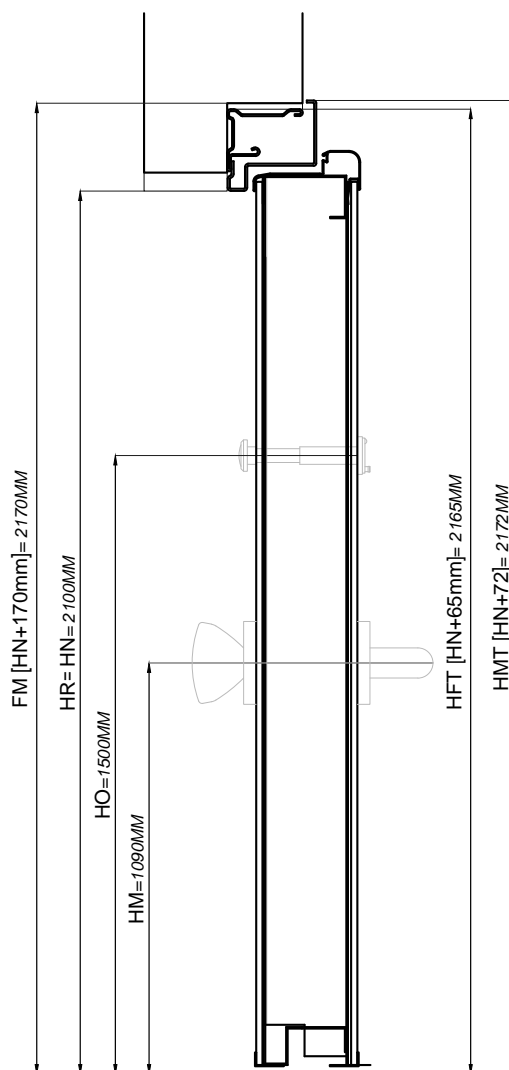
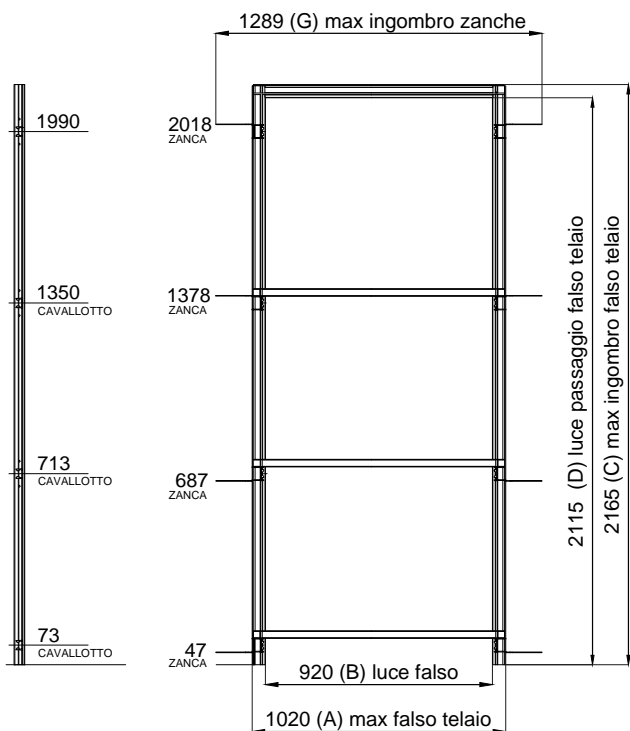

A	LARGHEZZA MAX INGOMBRO FALSO TELAIO	+120
B	LARGHEZZA LUCE FALSO TELAIO	+20
C	ALTEZZA MAX INGOMBRO FALSO TELAIO	+65
D	ALTEZZA LUCE FALSO TELAIO	+15
E	MASSIMO INGOMBRO ZANCHE MURATURA	+389

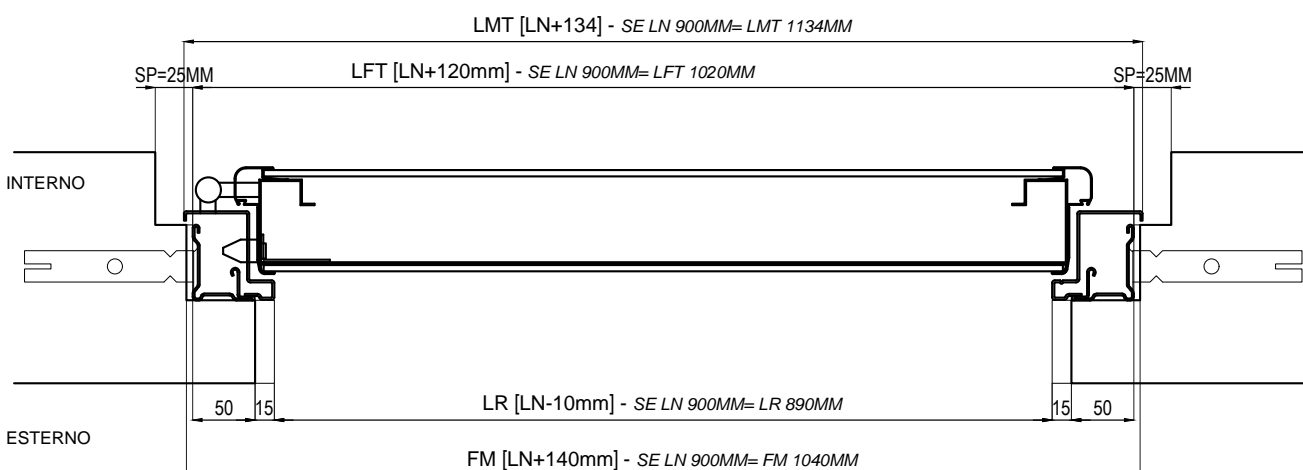

Esempio blindato 2100x900

LR / HR= luce reale di passaggio

LN / HN= luce netta di passaggio (parametro che si usa per la dimensione sull'ordine)

FM= Foro muro consigliato per installare il falso telaio SICURA. Sarà comunque necessario rompere il muro in prossimità delle zanche.

LFT / HFT= larghezza / altezza massima falso telaio

LMT / HFT= larghezza / altezza massima telaio

HO= altezza spioncino, visiva

HM= altezza maniglia

SP= Spalletta minima per posa corridoio/ contro parete 90°

Dettaglio pannelli Sicura

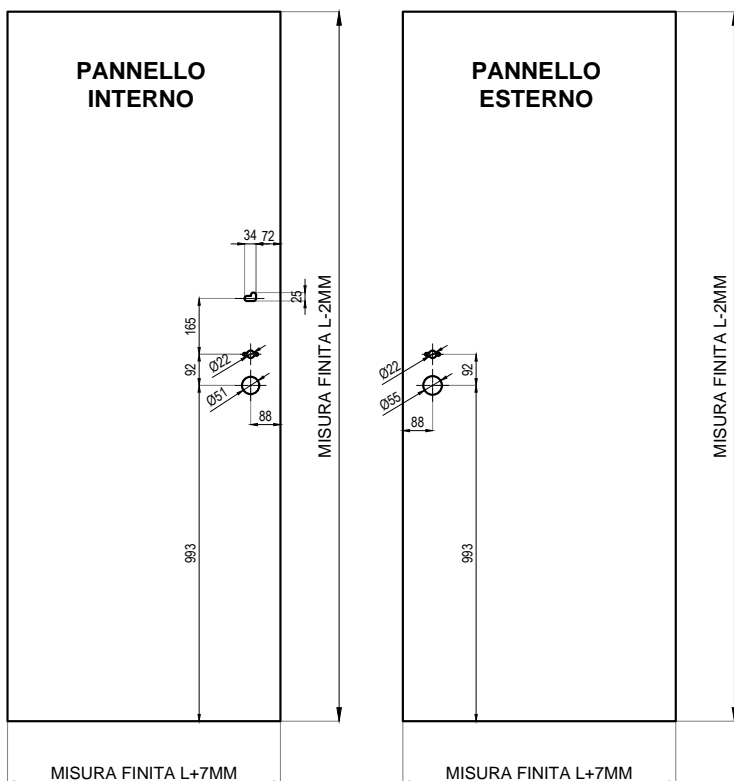

CARATTERISTICHE TECNICHE

MISURE PANNELLO INTERNO ED ESTERNO SICURA:
L+7 X H-2

ESEMPIO PANNELLO PORTA DA 900X2100MM
L=907 X H=2100MM

SPESSORE PANNELLO:
6MM

PER SPESSORI SUPERIORI NECESSARIO
RIBASSO PERIMETRALE SUI 3 LATI

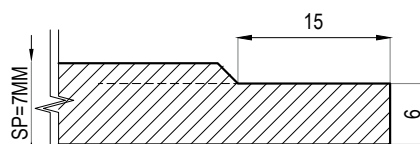

RIBASSO PERIMETRALE
SUI 4 LATI PER SPESSORE 6MM

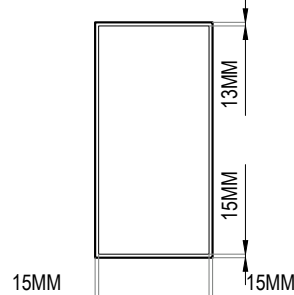

FORI MANIGLIERIA INTERNO PORTA

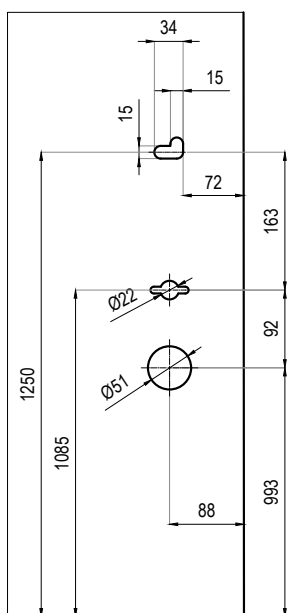

FORI MANIGLIERIA ESTERNO PORTA

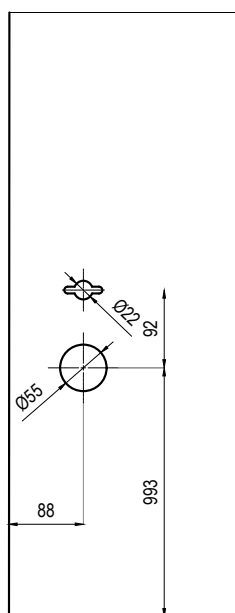
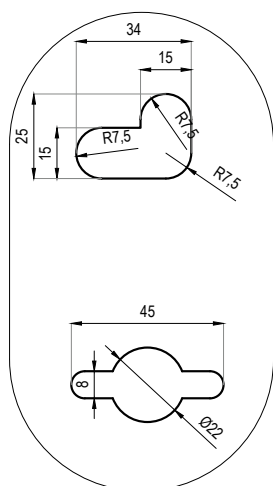



SCHIUMA PORTE INTERNE FAST ONE

Schiuma adesiva poliuretanicca rapida a bassa espansione che aderisce bene alla maggior parte dei materiali come legno, cemento, calcestruzzo, mattoni e cartongesso. Indurimento in meno di 1 minuto.

Con una bomboletta si posano 2,5 porte.

Ordine minimo 2 pezzi. Confezione XL 12 pezzi.



PISTOLA SILICONE

Ordine minimo 1 pezzo.



SILICONE ACETICO TRASPARENTE

Silicone acetico puro con elevata elasticità, adesione e resistenza alle alte e basse temperature. Resistente agli UV, non verniciabile e anticorrosione

Ordine minimo 2 pezzi. Confezione XL 12 pezzi.



KIT VITI POSA

Kit 6 viti con tappini copri vite.

Colori: bianco, nero, marrone, grigio e nocciola.

Ordine minimo 1 kit. Confezione XL 50 pezzi.



CUSCINO GONFIABILE

Cuscino gonfiabile per il posizionamento di porte e finestre.

Ordine minimo 1 pezzo.

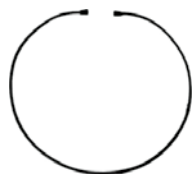

KIT MOLLA INSTALLAZIONE COPRIFILI

Kit 8 molle in acciaio con estremità morbida per installazione coprifili.

Ordine minimo 1 kit.



KIT AIR 180°

Coppia cerniere Air per l'apertura dell'anta a 180°.

Ordine minimo 1 kit. Confezione XL 50 kit.



KIT TELAIO 72

Lamelle per il restringimento del telaio.

Ordine minimo 1 kit. Confezione XL 50 kit.



- 1 Pedana di porte, messe in sicurezza dagli angolari in cartone, brevettati
- 2 Imballo testato anti rottura, protegge anche nel trasporto in verticale
- 3 Dettaglio angolari in cartone, brevettati
- 4 Angolari in polistirolo per porte laccate
- 5 Porte blindate confezionate singolarmente nell'imballo personalizzato
- 6 Telai in kit in scatola di cartone

RITIRA TU



48 ore di preparazione e con la e-mail di merce pronta il cliente si recherà al reparto spedizioni dove potrà ritirare le porte non pallettizzate. Orari di ritiro HUB1 Torre San Giorgio (CN): 7,30/12,00 - 13,00/19,00.

VETTORE



48 ore di preparazione + 24/48/72/96 ore di spedizione garantite da Palletways®.
Le ore di consegna dipendono dalle regioni, consultare la tabella destinazioni sul sito web.

CONSEGNIAMO NOI



48 ore di preparazione + tempistiche di consegna in base alla zona di scarico.
7/14 giorni. Consultare la tabella destinazioni sul sito web.

TIPOLOGIE DI PALLET PER VETTORE S/M/L

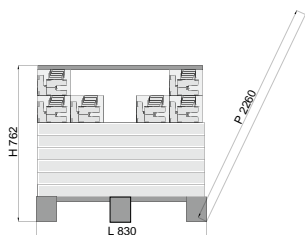

S

Bancale predisposto per accogliere fino a n° **6 ante** con relativo imballaggio e n° **6 scatole** Telai o Kit Scorrevoli con appositi coprifili.

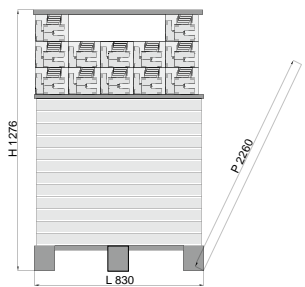

M

Bancale predisposto per accogliere fino a n° **12 ante** con relativo imballaggio e n° **12 scatole** Telai o Kit Scorrevoli con appositi coprifili.

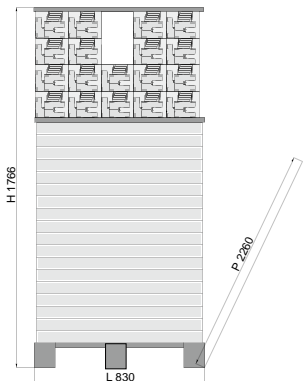

L

Bancale predisposto per accogliere fino a n° **18 ante** con relativo imballaggio e n° **18 scatole** Telai o Kit Scorrevoli con appositi coprifili.

- La porta blindata viene calcolata come 2 porte interne
- Il falso telaio assemblato viene calcolato come 1 porta interna
- Il falso telaio in kit smontato viene anche calcolato come 1 porta interna; può anche essere spedito con GLS / BRT singolarmente

PALLET XL E XL BLINDATE ESCLUSIVAMENTE “CONSEGNIAMO NOI”

XL

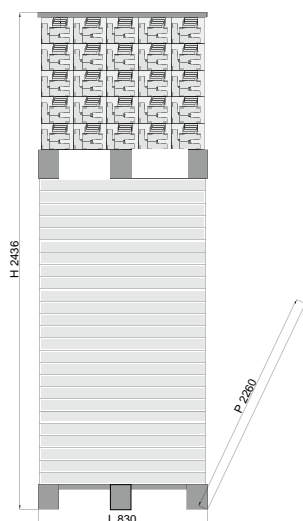

Bancale predisposto per accogliere fino a n° **25 ante** con relativo imballaggio e n° **25 scatole** Telai o Kit Scorrevoli con appositi coprifili.

N.B. LE SPEDIZIONI DI SOLI ACCESSORI (DA 1 A 3 PZ. DI KIT TEL/COP, SOLE MANIGLIE, KIT FERRAMENTA, KIT POSA, FALSI TELAI BLINDATE IN KIT SMONTATO) VERRANNO EFFETTUATE ESCLUSIVAMENTE CON VETTORE.

XL BLINDATE

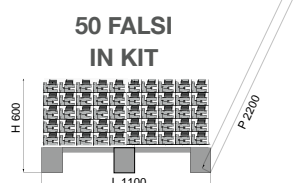
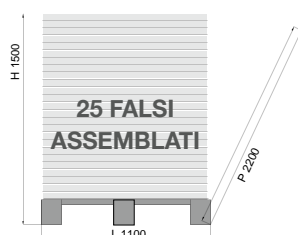
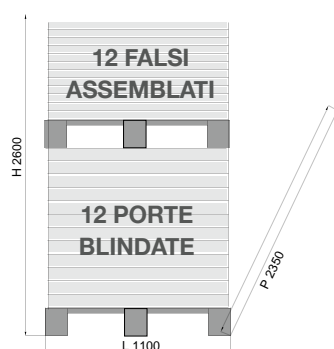

PROMOZIONE
3 pallet falsi kit smontati (150 pz)
4 pallet falsi assemblati (100 pz)
trasporto OMAGGIO

Bancale predisposto per accogliere fino a n° **12 porte blindate** con relativo imballaggio e n° **12 falsi telai assemblati** sovrapposti. Bancale predisposto per accogliere n° **50 falsi telai in kit smontati** oppure n° **25 falsi telai assemblati**

- Pallet XL: lo stock telai può essere composto solo da 25 telai o 25 kit scorrevoli. NO MIX.
- I kit non possono essere scomposti di componenti
- I sistemi ed elementi sopra elencati non sono ordinabili sfusi o in quantità inferiori a quelle indicate in tabella
- Le misure della porta battente 600/750/900 o scorrevole 600/900, possono avere il pallet XL con mix referenze misura e modello per raggiungere quota 25 pezzi. Per ante e kit telaio o kit scorrevole.

SISTEMI	QUANTITATIVI MINIMI	QUANTITATIVI SU PALLET XL PER STOCK
ANTA Imballata con protezioni angolari in polistirolo e film termofuso	1 anta	25 ante
TELAI/COPRIFILI - KIT SCORR. SCOMPARSA/COPRIFILI Kit completo di telaio, 5 aste coprifilo e ferramenta sfusa per l'installazione (imballati in scatola di cartone)	1 kit telaio o 1 kit scorrevole	25 kit telaio o 25 kit scorrevole
KIT SERRATURA	1 kit	50 kit
ALLARGAMENTI MURO 20/40/60 mm in kit Nelle finiture: Bianco Struttura/Calce/Bianco Hd/Bianco Laccato	1 kit da 3 aste	25 kit
ALLARGAMENTO MURO 230 mm Nelle finiture: Bianco Struttura/Bianco Hd/Bianco laccato/Noce Calce/Farro/Orzo/Riso	1 asta	25 aste
ALLARGAMENTO MURO 100 mm in kit Nelle finiture: Bianco Matrix/Avena Matrix/Latte/Corda/Bianco Laccato Bianco Hd/Bianco Micro/Ecrù/Noce/Band	1 kit da 5 aste	25 kit
COPRIFILO BIG 2250 mm Nelle finiture: Bianco Laccato, Bianco Micro, Noce, Ecrù	1 kit	25 kit
KIT ESTERNO MURO N° 1 binario con carrelli e fermi, n° 2 profili U allargatori anta bianchi e kit unghiate (imballati in scatola di cartone)	1 kit	25 kit
MANIGLIE Coppia di maniglie (in scatola)	1 maniglia	confezione XL 25 maniglie monoreferenza
MANIGLIE GOCCIA Coppia di maniglie (in scatola)	1 maniglia	confezione XL 50 maniglie monoreferenza
ROSETTE Coppia di rosette (in scatola) tonda, quadra, yale	1 rosetta	confezione XL 25 rosette

SISTEMI	QUANTITATIVI MINIMI	QUANTITATIVI SU PALLET XL PER STOCK
KIT UNGHiate Coppia di unghiate (in scatola) tonda, quadra, yale	1 rosetta	confezione XL 25 rosette
KIT L/O kit L/O (in scatola) tonda, kuader	1 rosetta	confezione XL 25 rosette
FILOMURO Ordinabile telaio accoppiato con anta, unica commessa	1 telaio 1 anta	22 telai 22 ante
BATTISCOPIA Nelle finiture: Matrix Avena/Bianco Struttura/Calce/Riso/Orzo/Farro Noce Nazionale/Bianco Laccato/Latte	1 kit da 5 aste	50 kit da 5 aste mix colori
KIT AIR 180°	1 kit	confezione XL 50 kit
RIVESTIMENTO BLINDATA N° 1 foglio di rivestimento sfuso imballato o montato direttamente su blindata	1 rivestimento	25 rivestimenti mix colori
BLINDATA Ordinabile con o senza falso telaio	1 blindata	12 blindate mix misure
KIT ANGOLARI FERMAPANNELLO Bianco Laccato/Bianco Hd/Bianco Micro/Bianco Struttura Bianco Matrix/Avena Matrix	1 kit	25 kit da 3 aste mix colori
FALSO TELAIO BLINDATA ASSEMBLATO Ordinabile con o senza blindata	1 falso	25 falsi telai
KIT FALSO TELAIO BLINDATA SMONTATO Ordinabile con o senza blindata	1 falso	50 falsi telai in kit
KIT MANIGLIERIA BLINDATO Tonda argento Quadra argento Tonda bronzo	1 kit	confezione XL 25 kit monoreferenza
SPIONCINO DIGITALE	1 kit	confezione XL 10 kit
MANIGLIONE ARGENTO	1 kit	confezione XL 10 kit

LEGENDA

(A)	Tipo Apertura anta
(B)	Tipo Binario
(C)	Colore/Finitura
(T)	Tipo/Telaio
(M)	Tipo Maniglia/Feramenta
(P)	Tipo Pannello/Disegno
(V)	Vetro

CATALOGO RISERVATO
AL RETAIL ITALIA
EDIZIONE 5
AGOSTO 2022

ProntoPorta
AUDASSO®

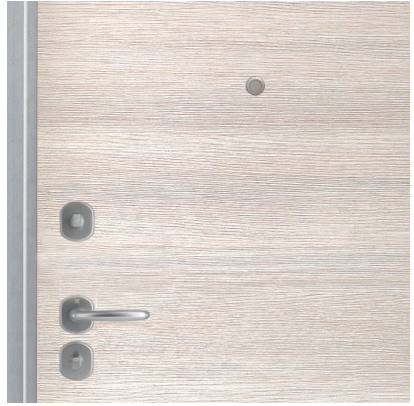

DISTRIBUITO DA

www.prontoportaaudasso.it